

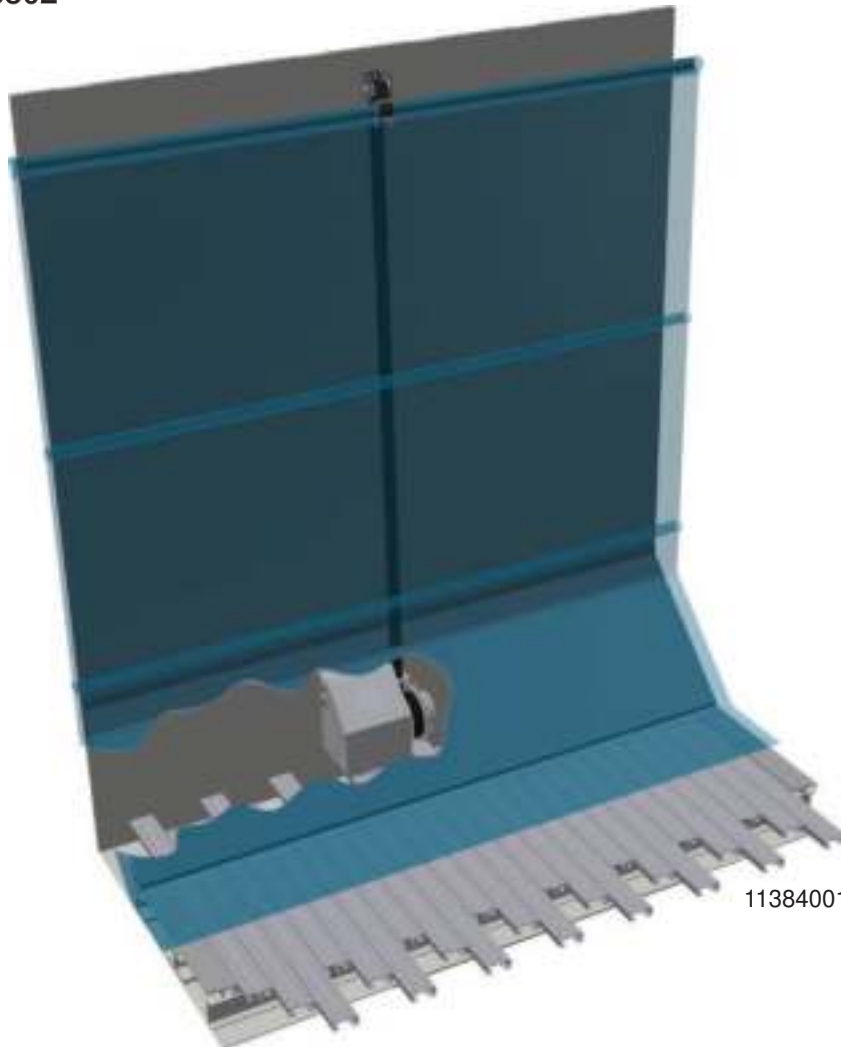

CleenSweep[®] Electric - CSE

KEITH Manufacturing Co.
www.KeithWalkingFloor.com
World Headquarters
Toll-Free: 800-547-6161
Phone: +1-541-475-3802



11384001



INSTALLATION / OWNER'S MANUAL & PARTS CATALOG

Original Instructions

©2022 KEITH Manufacturing Co. All Rights Reserved. KEITH, KEITH logo and WALKING FLOOR are registered trademarks of KEITH Manufacturing Co. Equipment manufactured by KEITH Manufacturing Co. is protected by numerous patents both domestic and foreign.

Table of Contents

Introduction	iii
CleenSweep® Tarp System Limited Warranty	iv
Warranty Registration Card	v
1.0 Safety	1
1.1 General Safety	1
1.1.1 Intended Function and Expected Use:	1
1.1.2 Improper Use	1
1.1.3 Training	1
1.1.4 Personal Protective Equipment	1
1.2 Design / Installation Safety	2
1.2.1 Electric Components and Installation	2
1.2.2 Controls	2
1.3 Marking of Machinery	3
1.3.1 Safety Decals	3
2.0 Specifications	5
2.1 System Identification	5
2.2 Technical Data	6
2.3 Component Identification	7
3.0 Installation	8
3.1 Winch & Strap Roller Mounting Position Options	8
3.2 Electric Winch & Strap Roller Installation	9
3.2.1 Option 1: Low Mount - Winch below front slope shield, strap roller near top of wall	9
3.2.2 Option 2: High Mount - Winch near top inside of trailer, strap roller on cap plate	12
3.2.3 Option 3: Outside Mount - Winch on outside of trailer, strap roller through front wall	14
3.2.4 Option for High Density or High Flow Materials	17
3.3 Winch Electrical Installation	18
3.3.1 Switch Control Box to Winch Connection	18
3.3.2 Winch to Trailer Electrical Installation	18
3.4 Tarp Assembly, Installation & Adjustment	22
3.5 Tarp Modifications for Bullnose Trailer	26
3.6 Tarp Modifications for V-Floor Trailers	27
3.7 Optional - Tarp Catch Hooks	27
3.8 Winch Brake Adjustment - Wedge Style	28
4.0 Operation	29
4.1 System Check - Initial Start-up	29
4.2 Normal Operation	30

**Operating
Instructions**

5.0	Troubleshooting	31
5.1	Check List	31
5.2	Problem / Solution - Troubleshooting	31
5.3	Electrical	32
6.0	Parts Catalog	33
	Winch Part Comparison Lists	33
	Conversion Kit - Battery Powered to Direct Connection System	37
	Strap Roller Assembly	38
	Wiring Components	38
	Tarp & Misc Components	39
	Winch Reference Drawing	40
	Wiring Diagrams	41
	CSE v1.0 Batteryless Direct Connect System - 10812701A	41
	CSE v2.0 Battery Powered System -10794201	42
7.0	Technical Support	43
8.0	Contact Information - KEITH Manufacturing Co.	43

Introduction

This manual explains procedures for installing and operating the KEITH® Electric CleenSweep® Tarp System. Many variables affect the installation, but the general process remains constant. Details of the installation vary, according to trailer features and installer preferences.

It is strongly recommended that the installers and operators read this entire manual before beginning the installation or operating of the system.

Please direct any questions to KEITH Manufacturing Co., one of our international offices listed in the contact information section of this manual, or on our website.

 **WARNING:** Always disconnect hydraulic and electric power to the trailer and follow lock out/tag out safety procedures before entering the trailer or working on the CleenSweep® Tarp System components. Failure to do so may result in serious injury or death due to the large forces involved with the CleenSweep® Tarp System.

IMPORTANT: Installing the CleenSweep® Tarp System requires some alterations to your trailer. Changes made without the approval of the trailer manufacturer may void the trailer's warranty.

CleenSweep® Tarp System Limited Warranty

This CleenSweep® Tarp System is warranted to the original purchaser to be free from defects in material and workmanship under normal use for a period of **one year** from the date of purchase. During the warranty period, and upon proof of purchase, the CleenSweep® Tarp System will be repaired or replaced with the same or similar model.

IT IS EXPRESSLY AGREED THAT THIS SHALL BE THE SOLE AND EXCLUSIVE REMEDY OF THE BUYER. UNDER NO CIRCUMSTANCES SHALL KEITH MANUFACTURING CO. BE LIABLE FOR ANY COSTS, LOSS, EXPENSE, DAMAGE, SPECIAL DAMAGES, INCIDENTAL DAMAGES, OR CONSEQUENTIAL DAMAGES ARISING DIRECTLY OR INDIRECTLY FROM THE USE OF THE CLEENSWEEP TARP SYSTEM. WHETHER BASED UPON WARRANTY, CONTRACT NEGLIGENCE OR STRICT LIABILITY.

THE WARRANTY AND LIMITS OF LIABILITY CONTAINED HEREIN ARE IN PLACE OF ALL OTHER WARRANTIES AND LIABILITIES, EXPRESSED OR IMPLIED. ALL IMPLIED WARRANTIES OF MERCHANTABILITY AND FITNESS FOR A PARTICULAR PURPOSE ARE HEREBY DISCLAIMED BY KEITH MANUFACTURING CO. AND EXCLUDED FROM THIS WARRANTY. FURTHER, KEITH MANUFACTURING CO. DOES NOT WARRANT THAT THE CLEENSWEEP TARP SYSTEM COMPLIES WITH LOCAL, MUNICIPAL, STATE OR FEDERAL CODES, IF ANY AND THE BUYER ALONE IS RESPONSIBLE FOR ANY KNOWLEDGE OF ANY COMPLIANCE WITH ANY SUCH CODES.

This warranty shall not apply to any parts that; (a) have been repaired or altered outside of the CleenSweep® Tarp System; (b) have been subjected to misuse, negligence or accident; or (c) have been used or installed in a manner contrary to CleenSweep® Tarp System instructions.

In certain circumstances some states do not allow the exclusion or limitation of incidental damages, some or all of the above limitations or exclusions may not apply to you. This warranty gives you specific legal rights and you may have other rights that vary from state to state.

If this warranty violates law: To the extent any provision of this warranty contravenes the law of any jurisdiction, that provision shall be inapplicable in such jurisdiction and the remainder of the warranty shall not be affected thereby.

Notice: To validate all warranties, a warranty registration card must be completed and returned to KEITH Manufacturing Co. within ten days of purchase. If you did not receive a warranty registration card, contact your dealer immediately.

Warranty Registration Card

Note: To validate the warranty, the registration information must be filled out completely and returned to KEITH within ten (10) days of purchase and/or installation.

Please fill out the Warranty Registration form on our website at www.KeithWalkingFloor.com or fill out the Warranty Registration Card below and mail or email it to:

KEITH Manufacturing Co.
 P.O. Box 1
 Madras, OR 97741-0001

TechDept@KeithWalkingFloor.com

This warranty registration card must be completed and on file at KEITH in order for the warranty period to begin on the purchase date. If no purchase date is registered, the beginning of the warranty will automatically revert to the manufacture date.

Name / Company Name: _____

Address: _____

City, State / Prov.: _____ Postal Code: _____

Country: _____

Phone: _____

E-Mail: _____

SYSTEM DATA:

Date of Purchase: _____

Model / Serial Number: _____

Purchased From: _____

Type of Material Loaded/Unloaded: _____

I have fully read the KEITH Manufacturing Co. warranty information and fully understand and agree to the terms of the warranty.

Name: _____ Date: _____ Signature: _____

1.0 Safety

1.1 General Safety

1.1.1 Intended Function and Expected Use:

- 1.1.1.1. The KEITH® CleenSweep® system is a winch system primarily intended to restage clean out systems used in live floor trailers. The system is supplied as a kit primarily intended for installation into mobile trailers or truck bodies. It is powered by an electric motor. The basic system is controlled by an electric push button. The system is compatible with options and accessories to improve performance. For example, it can be electrically controlled by hardwired or wireless remote.

1.1.2 Improper Use

- 1.1.2.1. This equipment has been manufactured utilizing state-of-the-art technology in accordance with acknowledged safety regulations. Nevertheless, dangerous situations could arise from improper use, which could endanger life and limbs of personnel and cause damage to the equipment and other assets. This equipment may only be used for its intended purpose. It may only be operated in impeccable technical condition and in accordance with the proper use and this user manual. Problems, which could affect safety, must be resolved immediately. The manufacturer is not liable for any damage caused by improper use or arbitrary modifications. The installation, commissioning, operation, and maintenance instructions must be followed as outlined in this manual.
- 1.1.2.2. Personnel must not enter the danger zone(s) when the system is enabled. Specifically, nobody should be inside, under, or behind the trailer in the unloading zone during operation. Additionally, no one should be in a full or filling trailer. Lock-out and tag-out procedures must be followed before accessing the drive area.
- 1.1.2.3. Control circuitry must not be altered or bypassed.
- 1.1.2.4. Safeguards must not be altered or bypassed.
- 1.1.2.5. The user and system designer must understand the characteristics and safe handling requirements of the material that is being conveyed.
- 1.1.2.6. Bulk materials are by nature unstable and flowable. Avoid burial by avoiding contact with the material.

1.1.3 Training

- 1.1.3.1. Operators must read and understand this manual before operating or maintaining the machine. Only qualified, trained personnel may execute commissioning, operation, and maintenance of the system.

1.1.4 Personal Protective Equipment

- 1.1.4.1. Always wear protective equipment appropriate for risks associated with each phase of the system's life, including transportation, installation, assembly, operation, inspection, maintenance, and dismantling, disabling, and scrapping. As a minimum, this includes the following personal protective equipment:

• Safety Glasses	• Protective/Traction Shoes
• Gloves	• Welding/Grinding Protection
• Helmets	• Thermal Protection (i.e. Coats)
• Hearing Protection	

1.2 Design / Installation Safety

1.2.1 Electric Components and Installation

- 1.2.1.1. KEITH recommends connecting to earth ground (whenever possible).
- 1.2.1.2. Wiring must be connected consistent with local codes and regulations, including electromagnetic interference regulations.
- 1.2.1.3. Adequate electric overcurrent protection must be provided.

1.2.2 Controls







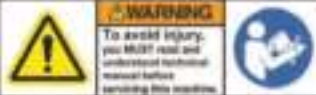

- 1.2.2.1. The control panel must be located such that it is easily accessible for all sizes and capacities of people, and allows the operator to move freely (whenever applicable).
- 1.2.2.2. Control devices must be located outside of danger zones, such that any exposed persons in danger zones are visible from the control station.
- 1.2.2.3. An acceptable means must be provided to monitor the status and movement of the load.

1.3 Marking of Machinery

1.3.1 Safety Decals



Decal Kit # 84804376

<u>Worded</u> Old - 2019	<u>Wordless</u> 2020 - Future	<u>Description</u>
		<p>To avoid injury, you MUST read and understand technical manual before operating or servicing this machine.</p>
		<p>Avoid injury. Do NOT operate with guard removed. Replace guard before operating machine.</p>
		<p>Hazardous voltage could cause serious injury. Stay clear. Lockout/tagout system power before servicing.</p>
		<p>Rotating parts and shaft can cut or entangle causing serious injury. Stay clear when in operation. Lockout/tagout before servicing.</p>

* Some or all of these safety decals may apply and be adhered to this system.

KEITH

MANUFACTURING CO

KEITH Manufacturing Co. World Headquarters 481 NW Adler St. Madras, OR 97741 USA	KEITH WALKING FLOOR Europe Harselaarsweg 113 3771 MA Barneveld The Netherlands
---	---

MODEL: <u>CSE DC</u> SERIAL # <u> </u> PART NUMBER: <u>10451101</u> D.O.M.: <u> </u> VOLTAGE: <u>10-30 VOLTS DC</u> UNIT WEIGHT: <u>47 LBS / 21.32 KG</u>	
--	---

www.KeithWalkingFloor.com

KEITH

MANUFACTURING CO

KEITH Manufacturing Co. World Headquarters 481 NW Adler St. Madras, OR 97741 USA	KEITH WALKING FLOOR Europe Harselaarsweg 113 3771 MA Barneveld The Netherlands
---	---

MODEL: <u>CSE 2.0</u> SERIAL # <u> </u> PART NUMBER: <u>10786501</u> D.O.M.: <u> </u> VOLTAGE: <u>10-30 VOLTS DC</u> UNIT WEIGHT: <u>68.8 LBS / 31.21 KG</u>	
---	---

www.KeithWalkingFloor.com

2.0 Specifications

2.1 System Identification

Battery Powered System with Trickle Charge - CSE v1.0 - **(OBSOLETE)**

- Assembly 09434002 - Obsolete - Replacement parts still available.
- Logic Module 85721339 - Obsolete - Will need to be replaced by a conversion to a Direct Connect system or a CSE v2.0
- Electrical Wiring Kit 85721335
- v1.0 to v2.0 Upgrade Instructions DOC06698A
- Converting Battery System to Direct Connect System - DOC06370
- Wiring Diagram 94735



Conversion Kit from Battery Powered System CSE v1.0 to Direct Connect System CSE-DC

- Assembly 09434002 with battery removed
- Logic Module 10812601
- Electrical Wiring Kit 10325001
- Wiring Diagram 10812701



Direct Connect System CSE-DC

- Assembly 10451101
- Logic Module 10812601
- Wiring Diagram 10329501



Battery Powered System with Trickle Charge - CSE v2.0

- Assembly 10786501
- Logic Module 10794401
- Wiring Diagram 10794201



2.2 Technical Data

CSE-U (10786501)	
Input Power (Nominal)	12 - 24 VDC
Input Power (Absolute min/max)	12.3* / 30 VDC
Supply Current	3.5 A
Charging Current	3 A
Charge Rate	~C / 10
Charging Type	3-Stage (See table in the Electrical Section)
External Host Charging Wiring	2-wire, 16 AWG / IEC 60228 1.5 mm
External Control Wiring	5-wire, 18 AWG / IEC 60228 1 mm
Internal Battery Type	12 VDC, 35 Ahr, AGM Group U1
Dimensions	356 mm x 438 mm x 248 mm [14" x 17.25" x 9.75"]
Weight	33 kg [72 lbs]
Operating Temperature	-23...50 C [-10...120 F]
Motor Speed	58 (+/- 5)
IP Rating	N/A (Individual internal components are sealed)

* If the Host (Truck) voltage drops below ~12.5VDC, the charger will begin to decrease output to prevent continued drain on the Host battery system.

2.3 Component Identification

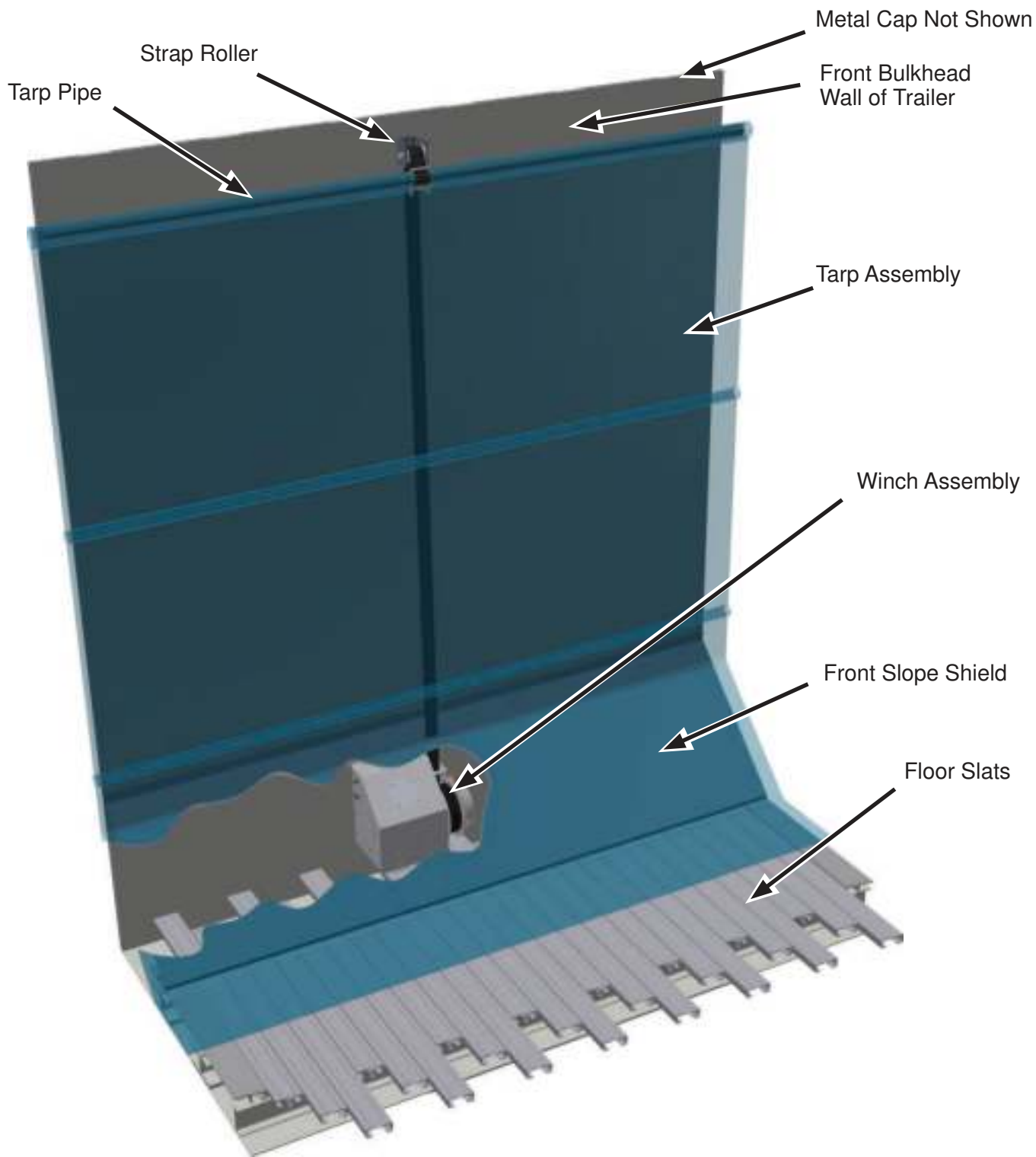

3.0 Installation

3.1 Winch & Strap Roller Mounting Position Options

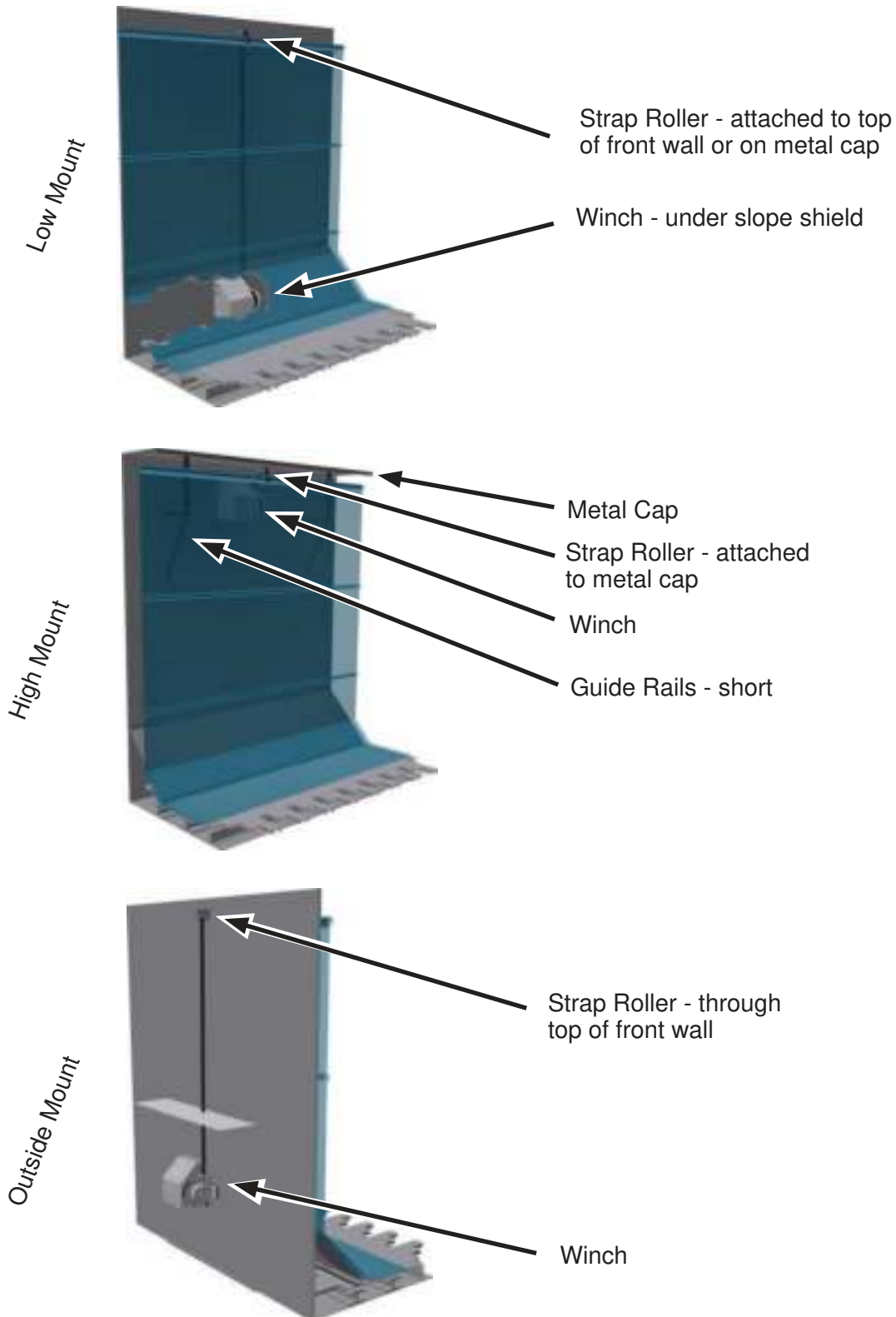

⚠ WARNING: Always disconnect electric and hydraulic power to the trailer and follow lock out/tag out safety procedures before entering the trailer or working on the CleenSweep® Tarp System components. Failure to do so may result in serious injury or death due to the large forces involved with the CleenSweep® Tarp System.

3.2 Electric Winch & Strap Roller Installation

3.2.1 Option 1: Low Mount - Winch below front slope shield, strap roller near top of wall

Low Mount - Winch mounted below the front shield. Requires the use of the strap roller assembly mounted near the top center of the front wall.

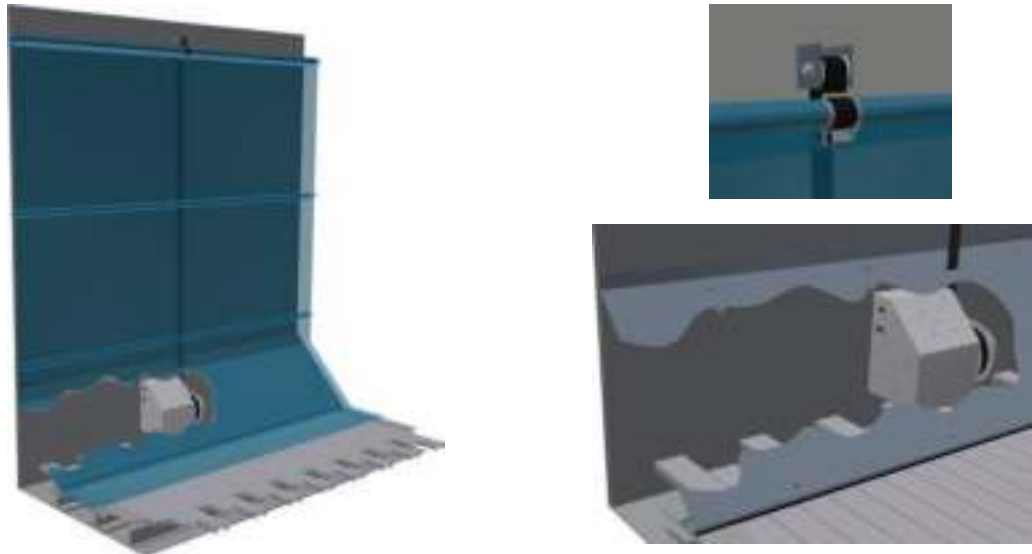

3.2.1.1 Winch Installation Below Slope Shield

NOTE: Front wall of trailer may need to be reinforced to withstand the forces created by the winch.

1. Locate and mark a centerline up the front wall of the trailer. **NOTE:** It is crucial that strap roller and the roll of strap on the winch is mounted in the absolute center of the trailer. If the winch is not mounted square, it will put uneven pressure on the tarp strap and the system will not function properly.

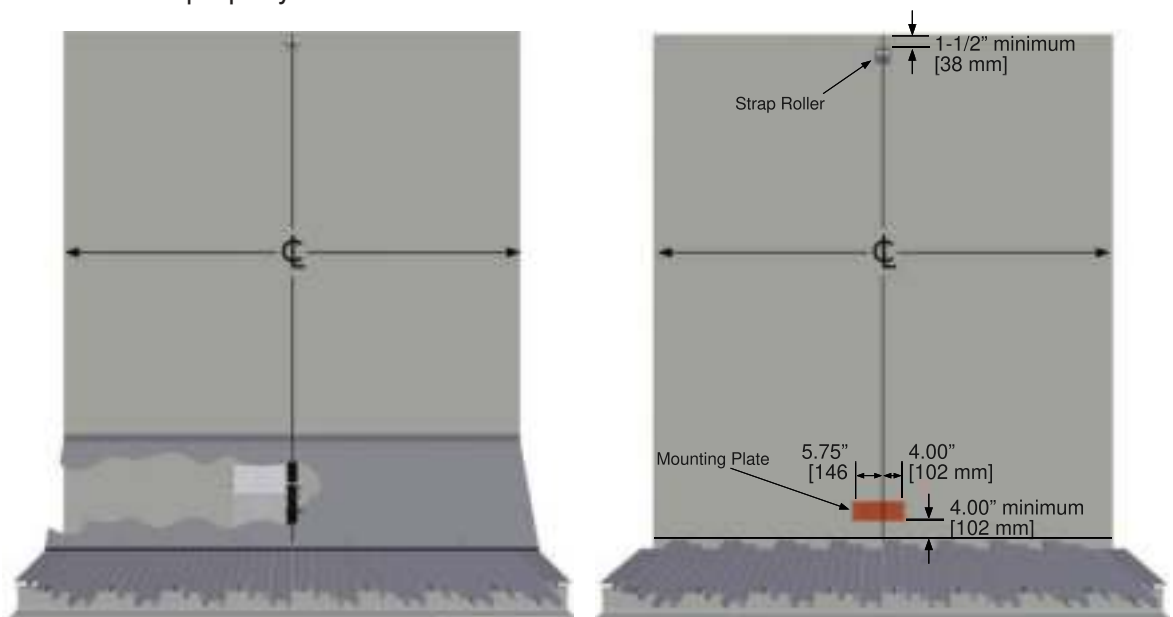

- The winch must not interfere with the operation of the floor slats, and there should be a 1" [25mm] minimum clearance between the winch and slats. Ensure all moving parts of the winch and floor have adequate clearance. Measure 4" [102 mm] up from the top of the floor slats to locate the bottom of the mounting plate.

A. WELD ATTACHMENT: Remove the winch mounting plate from the winch assembly, center on the front wall and weld. Then re-attach winch assembly to mounting plate using the (4) M10 bolts.

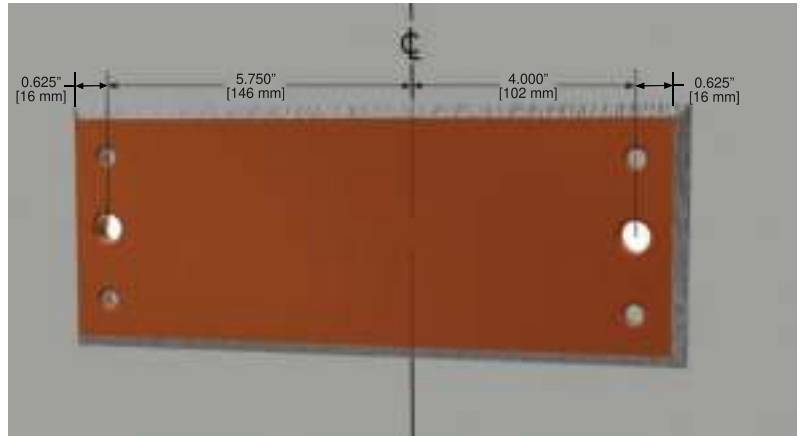

B. BOLT ATTACHMENT: Transfer the winch mounting plate mounting bolt hole pattern to the wall and drill (2) 17/32" [13 mm] bolt clearance holes. Then attach the entire winch assembly to the trailer wall using (2) 1/2" grade 8+ [M12 class 10.9+] locking fasteners (not included).

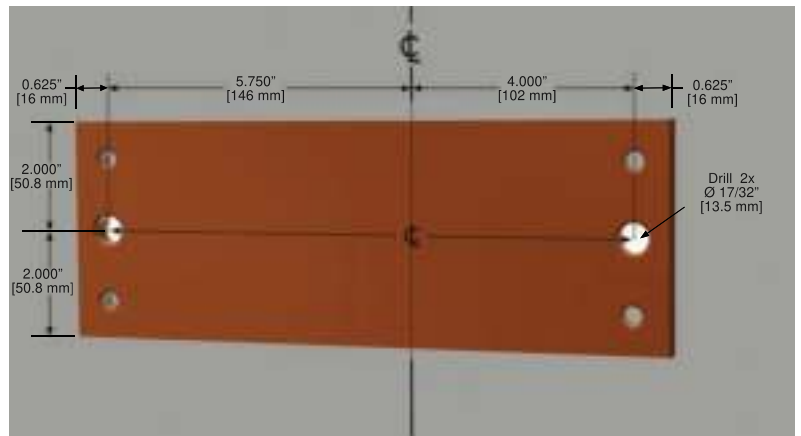

- Front shield modification: It is recommended that the front shield be hinged or fitted with a door/panel to gain access to the winch after it is installed to facilitate adjustment, inspection and maintenance.
- A slot must be cut through the front shield for the strap to pass through. The slot must be centered along the path of the strap from the winch to the strap roller assembly and all sharp edges removed or covered to prevent damage to the strap. Maintain at least 1/2" [13 mm] clearance all around the strap.

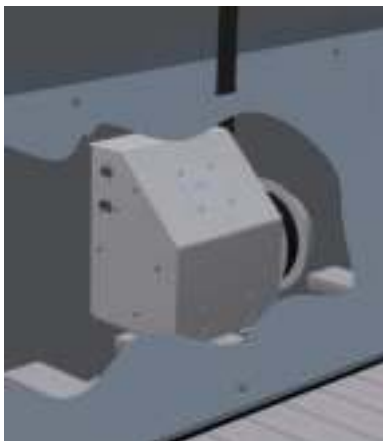

3.2.1.2. Strap Roller Assembly Installation Inside Trailer Near Top of Front Wall

NOTE: Front wall of the trailer may need to be reinforced to withstand the forces created by the winch.



1. Locate the centerline at the top of the front wall of the trailer.

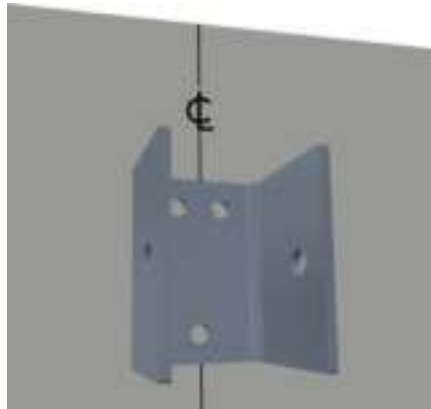

2. Measure down a minimum of 1-1/2" [38 mm] from the top to locate the strap roller mounting bracket.
3. Center the strap roller bracket with the two mounting holes toward the top of the wall and weld in place or transfer the strap roller bracket bolt pattern to the wall and drill (3) 7/16" [11 mm] bolt clearance holes.
4. Attach the strap roller to the front wall using (3) 3/8" grade 5+ [M10 class 8.8+] locking fasteners.

3.2.2 Option 2: High Mount - Winch near top inside of trailer, strap roller on cap plate



High Mount - Guide rails and a metal cap plate (not supplied by KEITH Manufacturing Co.) can be installed to allow the tarp to be pulled up higher in the front of the trailer. Doing so will reduce the possibility of material getting behind the tarp. A strap roller assembly is required, because the angle of the strap needs to change direction from vertical to horizontal when the tarp is fully extended. Mount the winch near the top center of the front wall of the trailer. The winch should be mounted with the strap up. Ensure all moving parts of the winch have adequate clearance.

3.2.2.1. Winch Installation Inside Trailer Near Top of Front Wall

NOTE: Front wall of trailer may need to be reinforced to withstand the forces created by the winch.

1. Locate and mark a centerline up the front wall of the trailer. NOTE: It is crucial that strap roller and the roll of strap on the winch is mounted in the absolute center of the trailer. If the winch is not mounted square, it will put uneven pressure on the tarp strap and the system will not function properly.

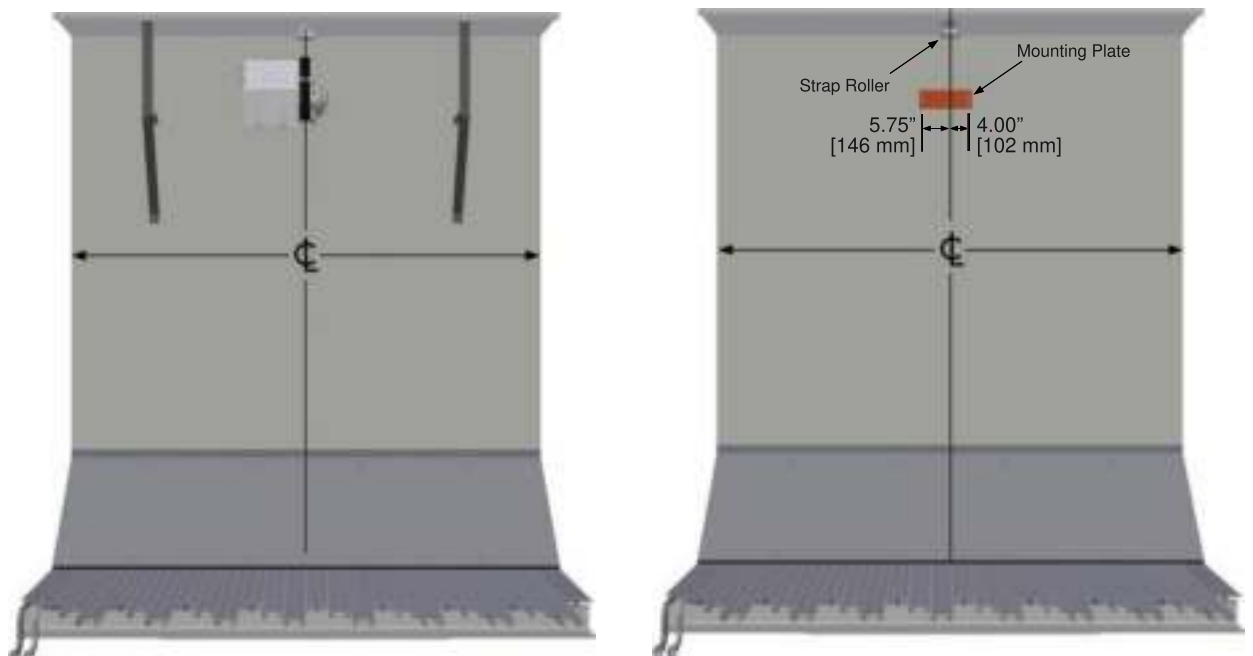

A. WELD ATTACHMENT: Remove the winch mounting plate from the winch assembly, center on the front wall and weld. Then re-attach winch assembly to mounting plate using the (4) M10 bolts.

B. BOLT ATTACHMENT: Transfer the winch mounting plate mounting bolt hole pattern to the wall and drill (2) 17/32" [13 mm] bolt clearance holes. Then attach the entire winch assembly to the trailer wall using (2) 1/2" grade 8+ [M12 class 10.9+] locking fasteners (not included).

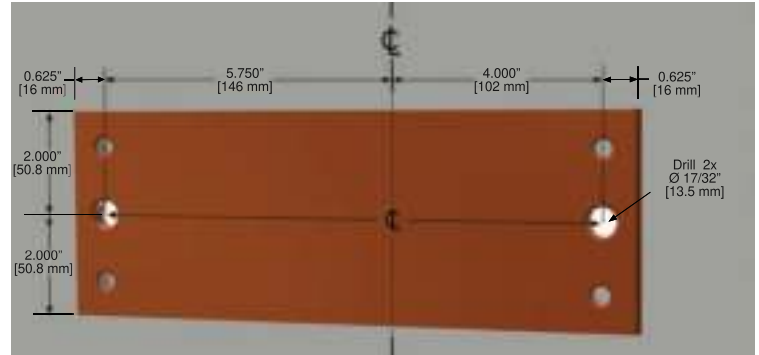
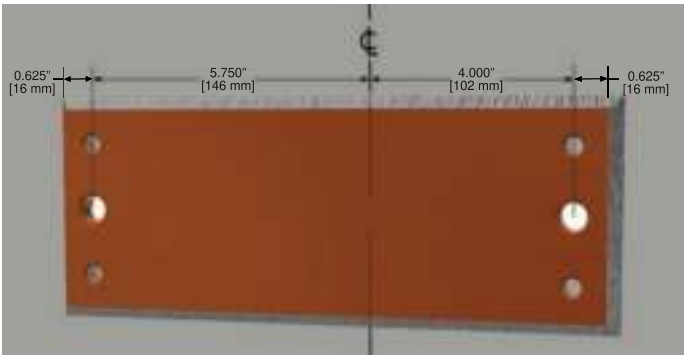

3.2.2.2. Strap Roller Assembly Installation on Metal Cap Plate

NOTE: Front wall of the trailer and cap plate may need to be reinforced to withstand the forces created by the winch.



1. Locate and mark the centerline of the cap plate.

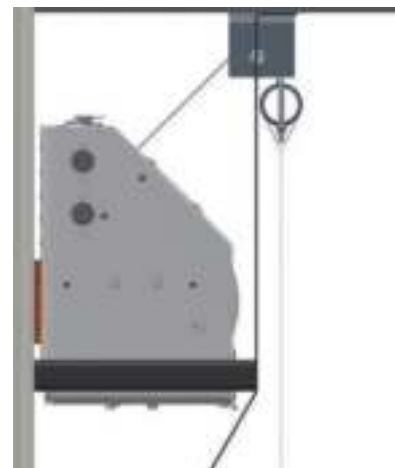
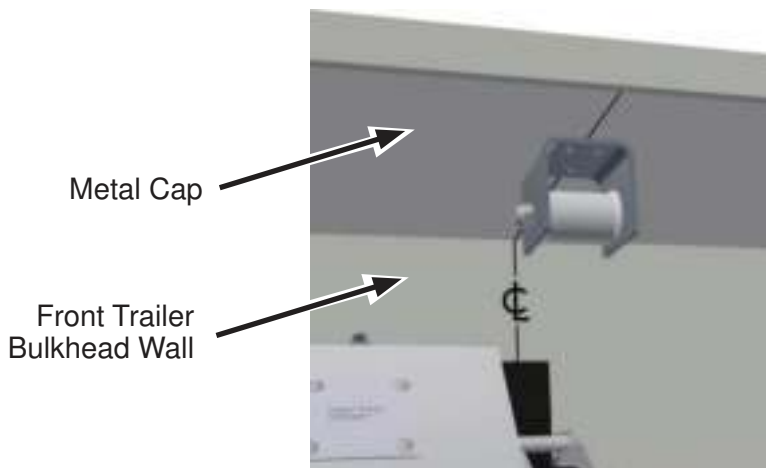

2. Locate the strap roller bracket far enough out from the front wall so that the tarp will hang straight down along the outside of the tarp guide rails when it is fully retracted. (See image)
3. Center the strap roller bracket with the two mounting holes toward the rear of the trailer and weld in place or transfer the strap roller bracket bolt pattern to the wall and drill (3) 7/16" [11 mm] bolt clearance holes.
4. Attach the strap roller to the cap plate using (3) 3/8" grade 5+ [M10 class 8.8+] locking fasteners.

3.2.3 Option 3: Outside Mount - Winch on outside of trailer, strap roller through front wall

Outside Mount - (Winch mounted on the outside of the front trailer wall) Requires the use of the strap roller assembly mounted in a hole cut through the front wall near the top center.



3.2.3.1. Winch Installation Outside of Front Trailer Wall

NOTE: Front wall of trailer may need to be reinforced to withstand the forces created by the winch.

1. Locate and mark a centerline up the front wall of the trailer. **NOTE:** It is crucial that strap roller and the roll of strap on the winch is mounted in the absolute center of the trailer. If the winch is not mounted square, it will put uneven pressure on the tarp strap and the system will not function properly.

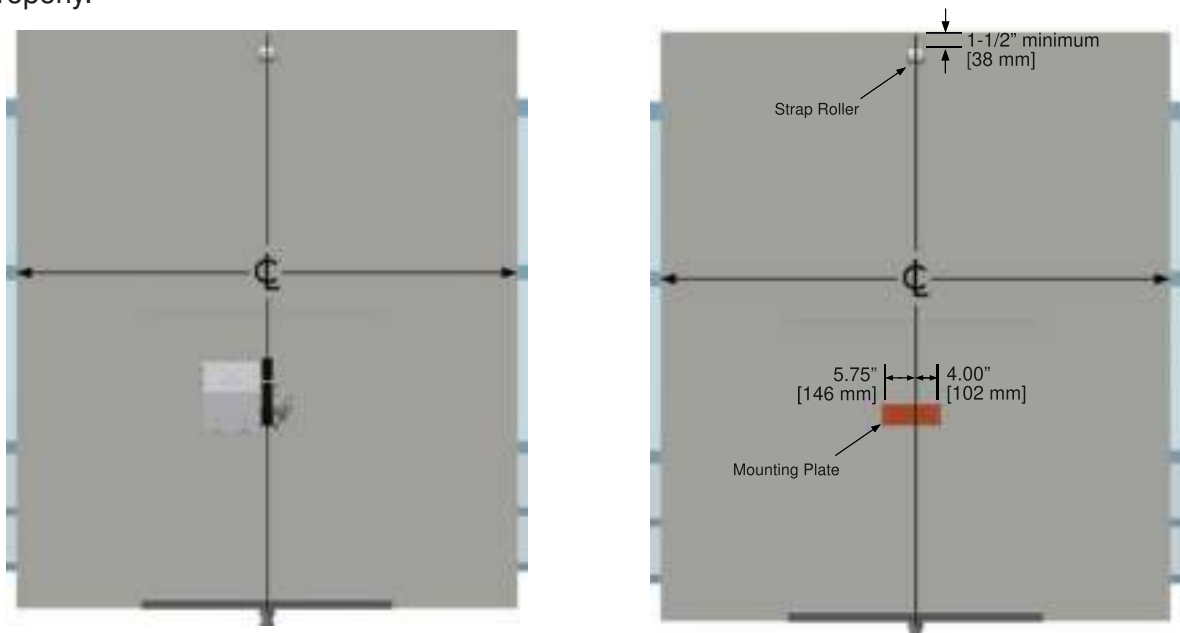

2. Ensure all moving parts of the winch and floor have adequate clearance.

A. WELD ATTACHMENT: Remove the winch mounting plate from the winch assembly, center on the front wall and weld. Then re-attach winch assembly to mounting plate using the (4) M10 bolts.

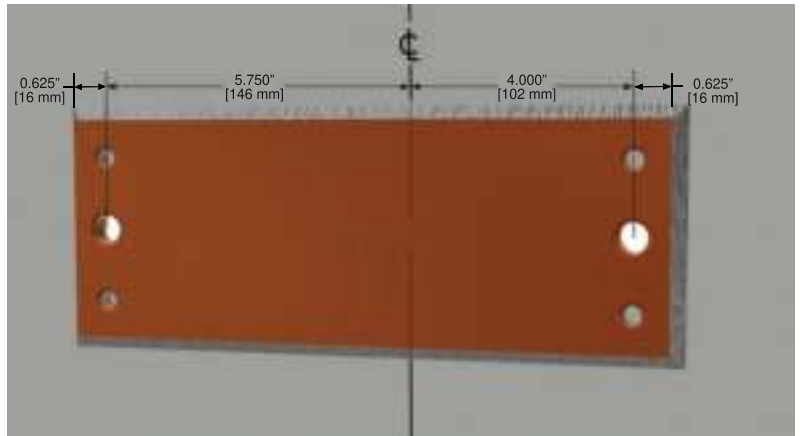

B. BOLT ATTACHMENT: Transfer the winch mounting plate mounting bolt hole pattern to the wall and drill (2) 17/32" [13 mm] bolt clearance holes. Then attach the entire winch assembly to the trailer wall using (2) 1/2" grade 8+ [M12 class 10.9+] locking fasteners (not included).

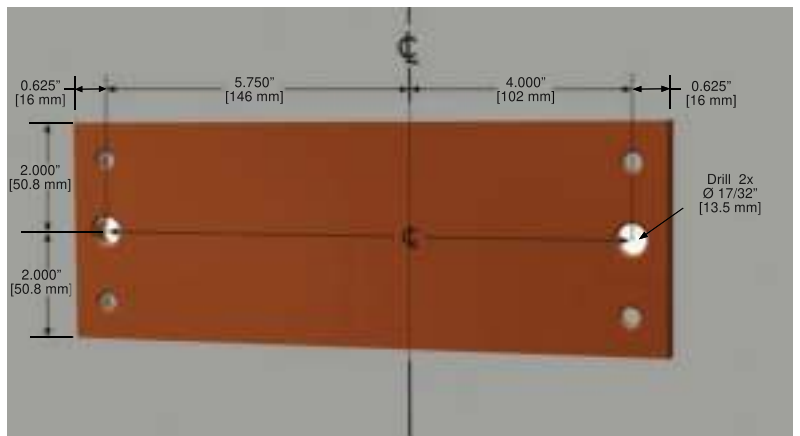

3. If the winch is mounted below the front wall platform, an opening must be made for the strap to pass through. The slot must be centered along the path of the strap from the winch to the strap roller assembly and all sharp edges removed or covered to prevent damage to the strap. Maintain at least 1/2" [13 mm] clearance all around the strap.



3.2.3.2. Strap Roller Assembly Installation Through Top of Front Wall

NOTE: Be sure to order appropriate bracket (aluminum, stainless steel) for welding.

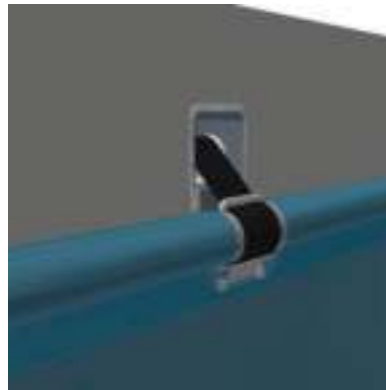

NOTE: Front wall and/or cap plate of the trailer may need to be reinforced to withstand the forces created by the winch.

1. Locate the center at the top of the front wall of the trailer.
2. Measure down a minimum of 1-1/2" [38 mm] from the top and cut a clearance hole completely through the front wall for the 3 in x 3 in [80 mm x 80 mm] strap roller mounting bracket.
3. Center the strap roller bracket in the cut out hole and weld in place.



View from Outside Trailer Wall

Leave clearance gap around head of nut & bolt for tool access

4. Install angle on lower inside edge of cut hole. Round and smooth all edges and welds to ensure that the strap is not damaged by burrs or sharp corners.

View from Inside Trailer

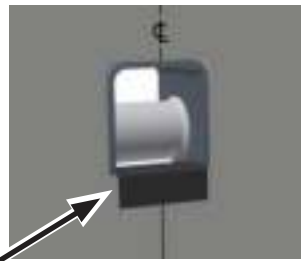

Smoothed angle

Remove all sharp edges from welds and around strap opening

3.2.4 Option for High Density or High Flow Materials

a. High Sided Trailer with Sloped Cap Plate:

- Prevents material from getting behind the tarp while loading and from getting stuck on top of cap plate.

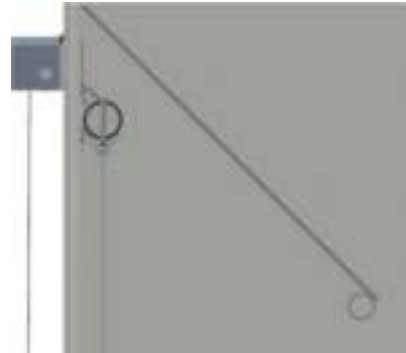
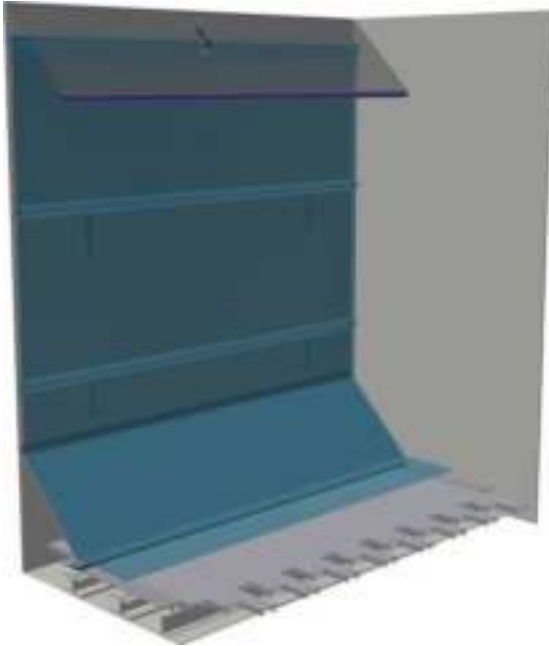

3.3 Winch Electrical Installation

 **WARNING:** The following requirements shall be met when installing or servicing electrical components in the CleenSweep® Tarp System.

- All connections to the host vehicle electrical system shall remain disconnected during the installation or servicing procedure.
- Prior to connecting wiring to the host vehicle terminals, verify wiring integrity with a voltmeter.
- Proper safety gear shall be worn during the installation.

 **CAUTION:** Failure to follow all requirements may result in present or future damage to your CleenSweep® Tarp System:

- Do not allow battery supply terminals and/or wires to contact conductive surfaces of the chassis.
- Ensure proper polarity is maintained when connecting power to the CleenSweep® Tarp System.
- Exercise care in wire routing, to avoid abrasion or damage, and possible shorting.
- Make sure all connections are waterproof and tight.

3.3.1 Switch Control Box to Winch Connection

Note: There are no user serviceable parts inside the winch system. The battery is a sealed AGM type and requires no service, although it is a wear part and will eventually need to be replaced.

1. Engage the <ESTOP> button (by pressing in until it latches), prior to performing this part of the installation process.
2. Install the Switch Control Box in the user preferred location using customer supplied frame mount and hardware. The maximum control cable length between the Switch Control Box and the CleenSweep® winch is 60'. The system comes with a 45' cable, and an optional 15' extension cable is available.
3. Route the control cable to the winch. The cable should be installed in a manner suitable for securing to the frame, to protect against road damage. To protect against future issues, do not kink or stretch the cable. Avoid running the cable near sharp edges or pinch points.
4. Connect the watertight connector at the Control Box, ensuring it is firmly snapped in place.
5. Connect the winch end of the control cable to the watertight connector located on the winch housing.

3.3.2 Winch to Trailer Electrical Installation

IMPORTANT: Please ensure the wiring between the winch system and the trailer is circuit protected with fusing provided by the installer.

3.3.2.1. Battery Powered System - CSE v2.0 (See Wiring Diagram Section)

1. Using the appropriate connector, connect a 16 AWG wire to the red lead at the winch mounted connector. Route this wire to a fused auxiliary DC power line, 10-30 VDC, at the front end of the trailer. This wire provides charging current to the local winch battery.
2. Following the same process as in the previous step, connect a 16 AWG black wire to the black lead at the winch mounted connector. This wire must be connected securely to the trailer ground.

Battery System Operation:

Battery Charger: The CleenSweep® Tarp System utilizes a multi-stage battery charging algorithm similar to any modern automotive battery charger, to maintain the charge on its internal 12 V AGM battery. The charger includes several safeguards:

1. The built-in DC/DC converter will operate from Host systems between ~12.3 to ~30 VDC, providing appropriate output to fully charge the local AGM battery.
2. STAT1 & STAT2 LED's can be observed as the multi-phase charging algorithm cycles through the following modes: Pre-condition – Bulk – Absorb- Float. Note: Each time the host power is cycled, the charger will re-start the charging cycles, cycling through them more quickly if the battery is already at full charge.
 - a. Pre-condition (for heavily discharged battery typically < 10 V): Charging current ~ .2 A.
 - b. Bulk (1st stage of 3-stage profile): Battery is charged with constant maximum current to bring the battery up to full voltage.
 - c. Absorption (2nd stage): Current is reduced while holding battery at a constant voltage of ~14.4 V. During this stage battery is brought to 100%.
 - d. Float (final stage): When charge current has dropped to ~1/10 of full charging current, or after ~4 hrs, the charger will enter float mode and maintain the battery at ~13.3 V. When the battery voltage drops below ~12.6 V e.g. by activating the winch, bulk is re-entered and cycles repeat.
3. If the Host supply voltage drops below ~12.5 VDC, the charger will begin to shut down to prevent continued drain on the Host battery system.
4. In the event the local battery becomes severely discharged, the charger will initialize a trickle charge to attempt to restore the battery to minimum working voltage, before moving into regular charging modes. If the battery fails to respond to conditioning, the charger will suspend charging.
5. If the local battery fails, causing battery voltage to be < ~3 V, the charger will shut down and no charging will occur.
6. Red Fault LED will be on during bad battery or over-voltage faults, or in the event of charger-overheating. Fault condition can only be reset with power cycling of system.

3.3.2.2. Direct Connect - CSE - DC (Battery-less Installation DOC06691A) (See Wiring Diagram Section)

The Battery-Less CleenSweep® Tarp System is designed to operate from the host vehicle +12 VDC power system, rather than from a dedicated, local battery. Significant currents are required to operate the winch motor, therefore appropriate wire sizing, connectors and circuit protection are all important for proper operation and safety.

⚠ WARNING: The following requirements shall be met when installing or servicing electrical components in the CleenSweep® Tarp System.

- All connections to the host vehicle electrical system shall remain disconnected during the installation or servicing procedure.
- Prior to connecting wiring to the host vehicle terminals, verify wiring integrity with a voltmeter.
- Proper safety gear shall be worn during the installation.

⚠ CAUTION: Failure to follow all requirements may result in present or future damage to your CleenSweep® Tarp System:

- Do not allow battery supply terminals and/or wires to contact conductive surfaces of the chassis.
- Ensure proper polarity is maintained when connecting power to the CleenSweep® Tarp System.
- Exercise care in wire routing, to avoid abrasion or damage, and possible shorting.
- Make sure all connections are waterproof and tight.
- Allow for cable flex and avoid stretching the cable tight between bends or connections.
- Circuit protection must be installed within 6" [152 mm] of the host vehicle positive power terminal to protect downstream wiring & systems.
- Returning ground shall be made directly to the battery negative terminal and not chassis ground.

Tools and Supplies Required

- Wire cutters capable of cutting up to 2 AWG cable.
- Wire stripping tool, capable of stripping wire and cable up to 2 AWG.
- Crimping tool capable of crimping Anderson 6 AWG contact pins.
- DC Multimeter
- Assorted automotive cable clamps, wire tie straps, etc. as needed.

General Specifications

Parameter	Value	Duration
Operating Voltage	12-14 VDC	Continuous
Current (Retrieve)	~25 A	~30 sec 1
Current (@Stop)	70 to >150 A	<1 to ~90 sec 2

- Retrieve duration depends on trailer length.
- In certain conditions such as with a new clutch, some clutch slippage may be experienced initially, causing the motor to run longer in the fully retracted position. As the clutch is burnished from use, clutch holding friction increases, causing motor current to also increase at the fully retracted position. This increased current at the retracted position will be detected and cause the system to stop the motor more quickly.

Wire Sizing

The following is useful as a wire-sizing guide; however, installer should consider these numbers as minimum gauge values. It is recommended that wiring be done by experienced personnel.

Wire Gauge*	Wire Length (round - trip distance)	Wire Gauge (cont.)	Wire Length (round - trip distance) (cont.)
8 AWG	<20'	4 AWG	60'
8 AWG	20'	4 AWG	70'
6 AWG	30'	2 AWG	80'
6 AWG	40'	2 AWG	90'
4 AWG	50'	2 AWG	100'

* Use stranded cable meeting SAE J1127 as a minimum specification.

1. Using the Wire sizing table, route and secure appropriate power and ground cables from the host vehicle battery to the CleenSweep® System. DO NOT connect to the host battery yet.
2. Cut and strip the cable ends at the CleenSweep® Tarp System for the Anderson connector using the connector pin as a strip gauge.
 - a. Crimp the connector contact pins on the stripped cable ends using a heavy gauge wire crimping tool such as APP P/N SBcrimp <https://powerwerx.com/hex-crimping-tool-sb-series-powerpole> Or APP P/N HYD-1 <https://powerwerx.com/hydraulic-crimping-tool-sb-powerpole-contacts>
 - b. Insert the contact pins into the housing making sure the red (+) and black (-) wires will be aligned with their matching counterpart when the connectors are mated.
 - c. DO NOT mate the connector yet.
3. Cut and strip the cable ends near the host system battery terminals.
 - a. Using an Ohmmeter:
 - i. Measure between the Red and Black cables to verify there are no shorts.
 - ii. Measure between the Red cable and chassis ground to verify there are no shorts.
 - b. Attach the Red (+) cable via a FUSED CONNECTION, to the positive terminal.
 - i. An 80 Amp fuse is recommended at the battery terminal. Automotive circuit breakers do not typically have a high enough Interrupt Current rating for the amperage a truck battery is capable of delivering.
 - ii. Example fuse: Littelfuse Inc. 0298080.ZXEH MEGA® 32 V Automotive fuse.
 - c. Attach the Black (-) cable to the negative terminal.
4. Using a voltmeter:
 - a. Verify property voltage and polarity is present at the Anderson connector located at the CleenSweep® Anderson connector.
5. Mate the Anderson connector halves to supply power to the CleenSweep®
6. Verify proper CleenSweep® operation (Stop button should be pulled out):
 - a. Pull out tarp and retract using Manual mode setting and Retract toggle switch.
 - b. Pull out tarp and retract using Automatic mode setting and toggle switch.
 - c. Press Hold toggle switch and verify the tarp is held by clutch engagement.
 - d. Verify Stop Button stops tarp movement during retract operation.
7. Installation is complete.

3.4 Tarp Assembly, Installation & Adjustment

Please note that pipes, strips and fasteners are not supplied by KEITH Manufacturing Co. For the top pocket, located at the top of the tarp when fully retracted and hanging, (1) 2" [50 mm] diameter lightweight metal conduit pipe is recommended. For all other pockets, use 1-1/2" [40 mm] diameter lightweight metal conduit pipes or 1/4" x 3" [6 mm x 76 mm] UHMW plastic strips.

1. Cut the pipes/strips approximately 2" [50 mm] shorter than the inside width of the trailer. Take this measurement just above the trailer floor, at the trailer's narrowest point.
2. If the tarp is wider than the width of the trailer, cut the tarp to the same width as the inside of the trailer. Remove half of the material from each side of the tarp.

Note: If you are installing the tarp into a trailer with a V-Floor® system or into a bullnose trailer, the tarp will need to be wider than the inside of the trailer because the tarp will conform to the ridges on the floor or the nose of the trailer. See Tarp Modifications for V-Floor Trailers for additional instructions.

If using Pipe in lower pockets:

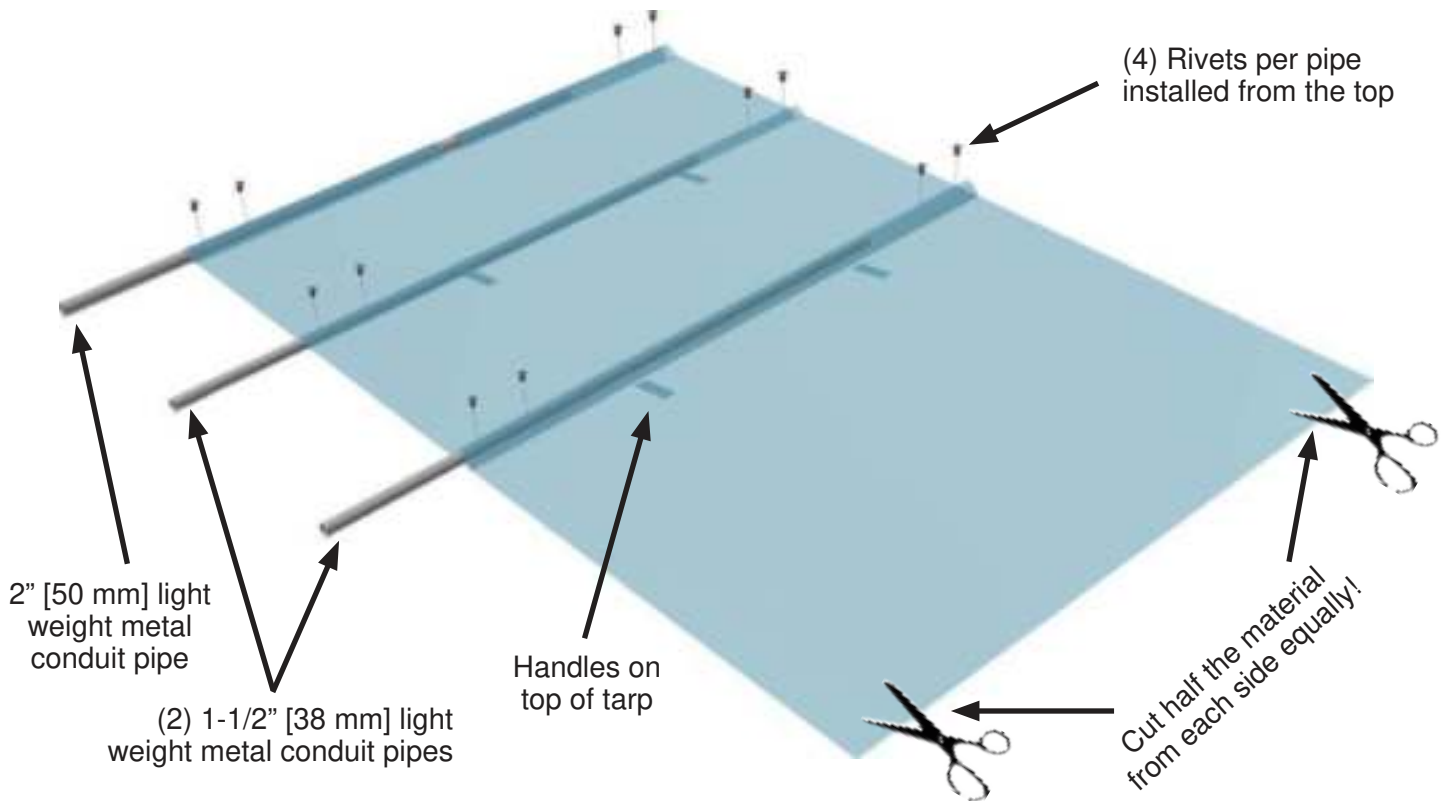

- A. With the tarp laying down on the floor of the trailer, center the 2" [50 mm] pipe in the top pocket of the tarp which has the notch cut out in the center. On the top side of the pipe drill (4) holes through the tarp and pipe and install rivets (not supplied) to hold the pipe in place.
- B. Center the smaller diameter pipes in the lower pockets of the tarp. On the top side of the pipes drill (4) holes through the tarp and pipes and install rivets (not included) to hold the pipes in place.

If using UHMW strips in lower pockets:

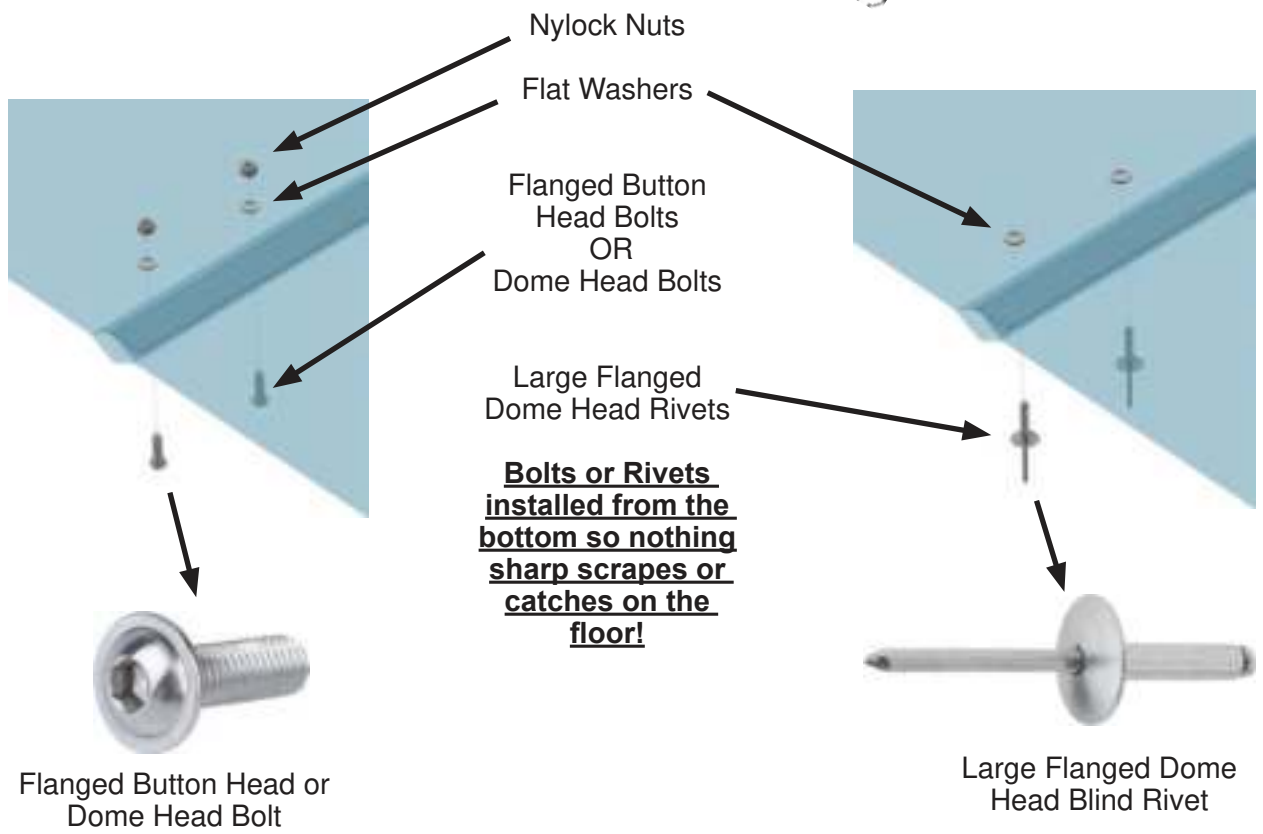
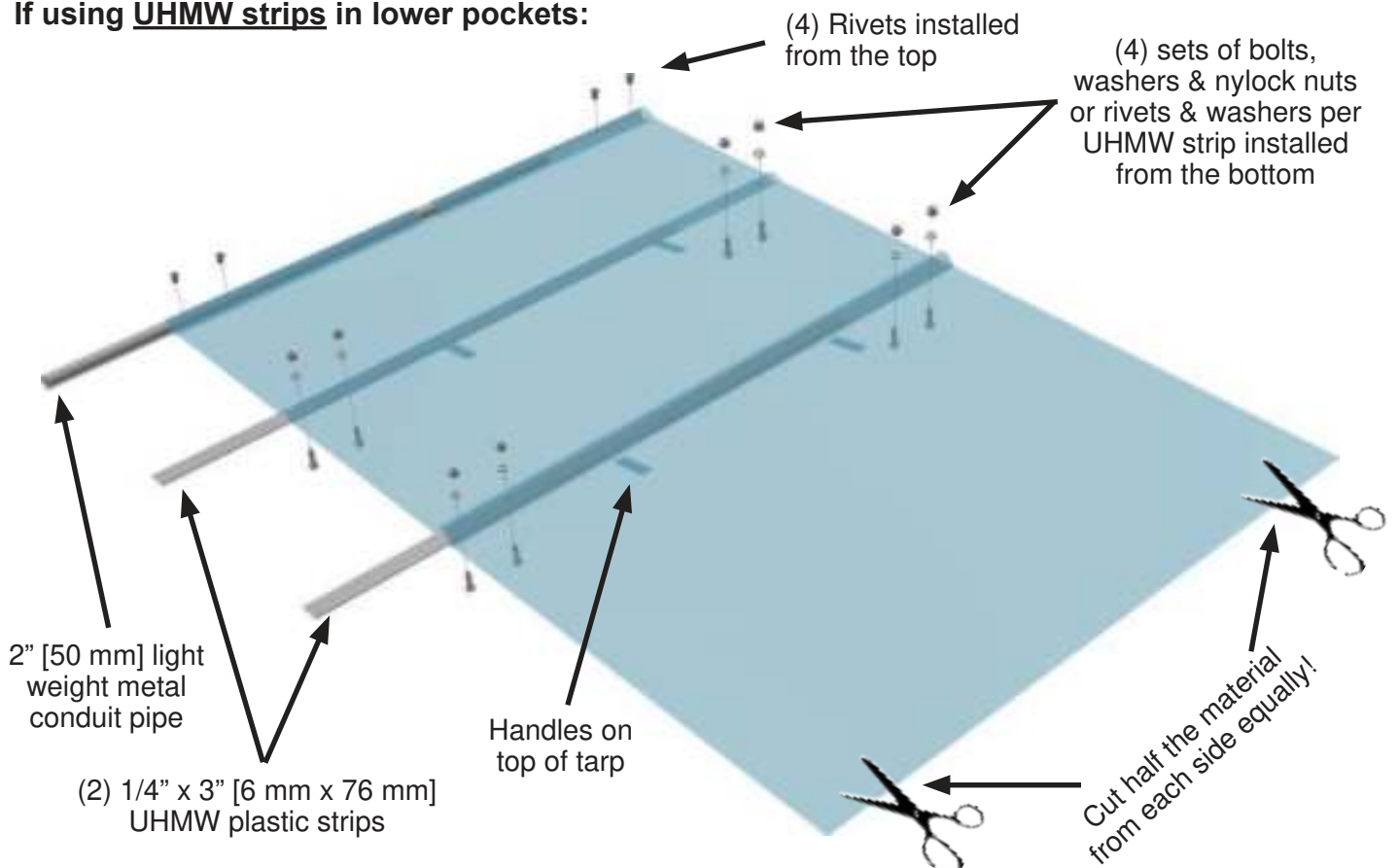

- A. With the tarp laying down on the floor of the trailer, center the 2" [50 mm] pipe in the top pocket of the tarp which has the notch cut out in the center. On the top side of the pipe drill (4) holes through the tarp and pipe and install rivets (not supplied) to hold the pipe in place.
- B. Center the UHMW strips in the lower pockets of the tarp. Drill (4) holes completely through the tarp and UHMW strips. Use bolts with washers and nylock nuts (not supplied) or use rivets with washers (not supplied) to keep the UHMW strips in place. Bolts or Rivets should be installed from the bottom so nothing sharp scrapes or catches on the floor.
3. Find the center of the top pipe when the tarp is in the hanging position. Drill (2) 3/8" [9.5 mm] holes, evenly spaced, through the top pipe to attach the U-bolt. It must be centered and installed so that when the tarp is hanging from the winch, the threads of the U-bolt are facing downward. If necessary, you can make the notch in the tarp wider in the middle to accommodate the U-bolt.
4. Lay the tarp in the rear of the trailer, with the handles on top of the tarp and the 2" [50 mm] top pipe resting inside of the trailer about 12"-24" [305-610 mm] (depending on type of material being unloaded) making sure it is not past the ends of the slats when they are retracted to the front. This will be where the tarp stops during unloading with the rest of the tarp hanging off the back of the trailer.
5. Release the winch strap brake and thread the strap through the strap guide on the winch, through the slot in the front shield (if winch is low-mounted) and through the strap roller. Pull (unwind) all of the loose strap completely off of the winch, so the attachment screws are visible, and stretch it out past the end of the trailer, making sure that the strap is not twisted.

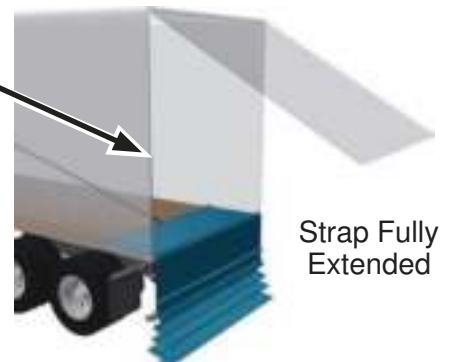
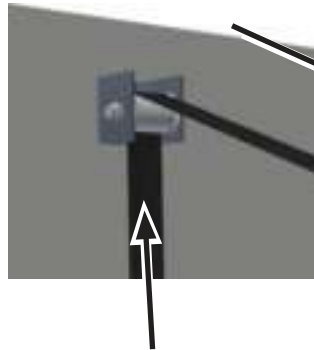
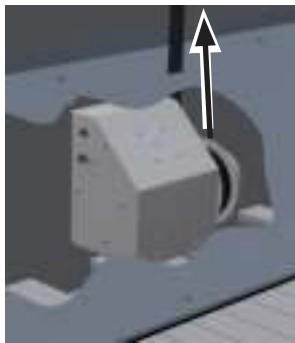

6. Cut the strap off, leaving enough strap to wrap loosely around the top pipe 3 times, pull tight and tighten the U-bolt to hold the strap securely in place. This will keep the top pipe of the tarp from falling out of the trailer when the strap is fully extended.

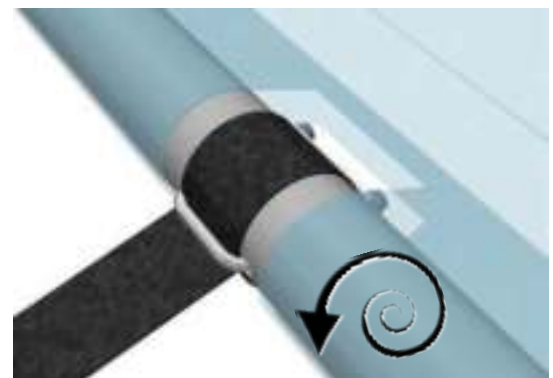
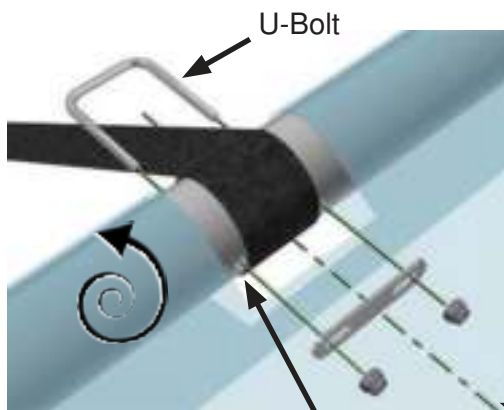

Wrap the end of the strap around the top pipe (3x) and secure it to the pipe using the U-bolt assembly.

Drill (2) 3/8" [9.5 mm] holes through the top pipe for mounting the U-bolt

Align centerline of tarp with centerline of top pipe

7. Retract the tarp assembly completely so that the U-bolt is back to the strap roller. Cut the tarp to length leaving a minimum of 12"-14" [305-356 mm] of tarp on the floor covering the slats. Too much tarp on the floor and the tarp will get caught in the unloaded material and be difficult to remove. Too little tarp on the floor and it won't move along with the load and sweep cleanly. Additional tarp on the floor (36"-48" [914-1219 mm]) may be needed if the material being unloaded is very light weight (low density).

Top of Tarp - Retracted

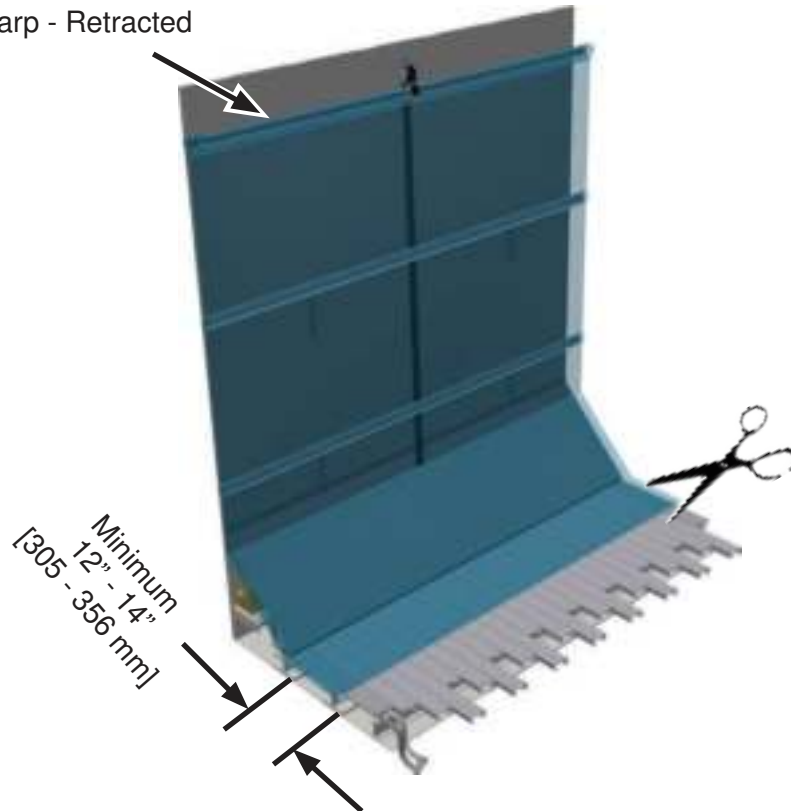

3.5 Tarp Modifications for Bullnose Trailer

NOTE: Front wall and cap plate of the trailer may need to be reinforced to withstand the forces created by the winch.

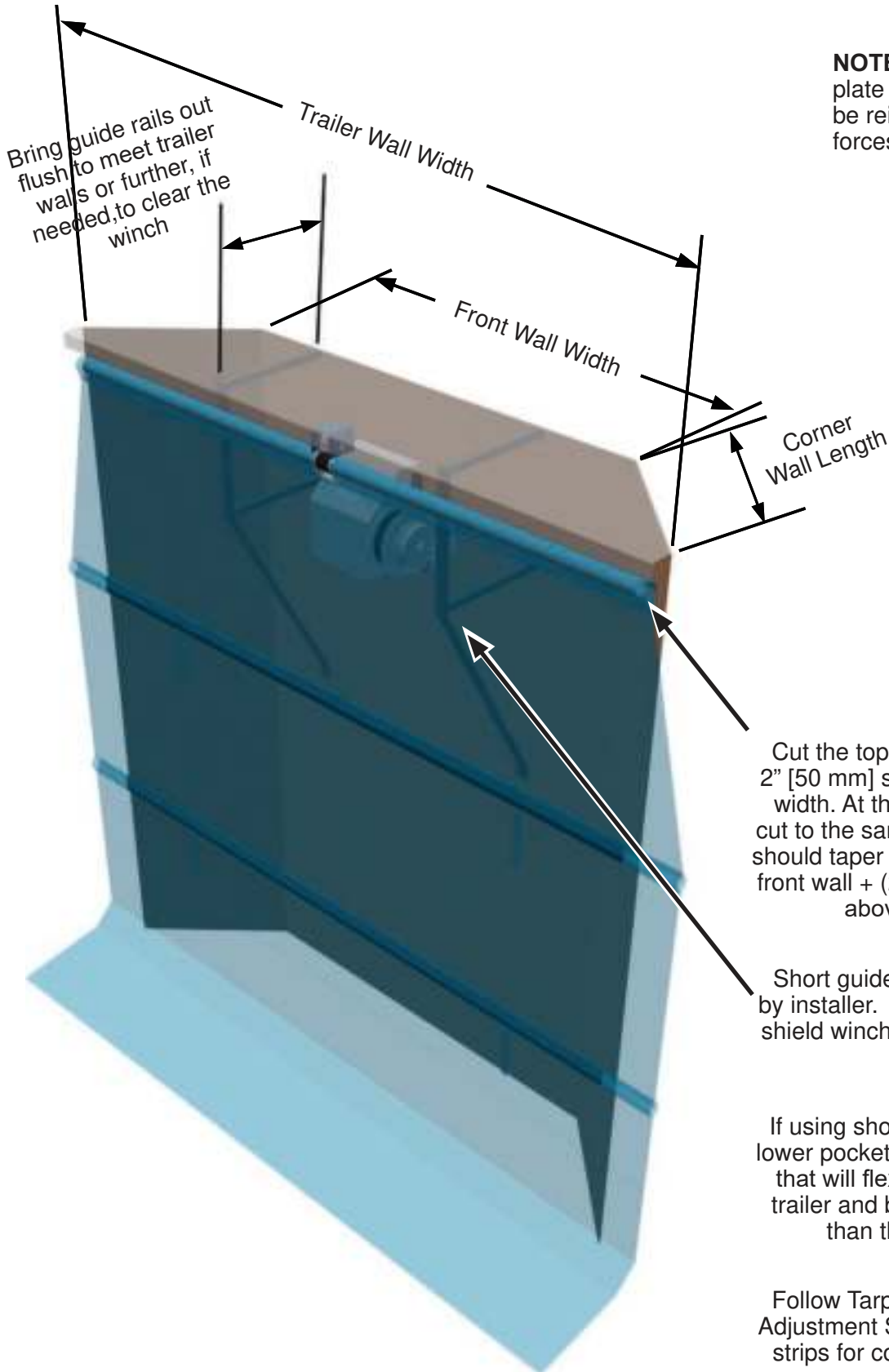

Cut the top light weight conduit pipe 2" [50 mm] shorter than the trailer wall width. At the top, the tarp should be cut to the same width as the trailer and should taper out to the total width of the front wall + (2x) corner wall length, just above the first pocket.

Short guide rails (shown) fabricated by installer. Should be long enough to shield winch or other objects attached to front wall.

If using short guide rails (shown) the lower pockets must have UHMW strips that will flex into the bullnose of the trailer and be cut 2" [50 mm] shorter than the trailer wall width.

Follow Tarp Assembly, Installation & Adjustment Section 3.10 using UHMW strips for complete tarp instructions.

3.6 Tarp Modifications for V-Floor Trailers

Note: If you are installing the tarp into a trailer with a V-Floor® system or into a bullnose trailer, the tarp will need to be wider than the inside of the trailer because the tarp will conform to the ridges on the floor or the nose of the trailer. For a V-9 system, the tarp should be approximately 6" [152 mm] wider than the inside of the trailer. For a V-18 system, the tarp should be approximately 7" [178 mm] wider.

- Start in the middle of floor and place weights or (gravel, dirt, etc) on the tarp between all the slats to hold the tarp down so it conforms to all of the slats.
- Cut both sides of the tarp **equally** along the trailer wall so that the tarp is now the same width as the trailer.

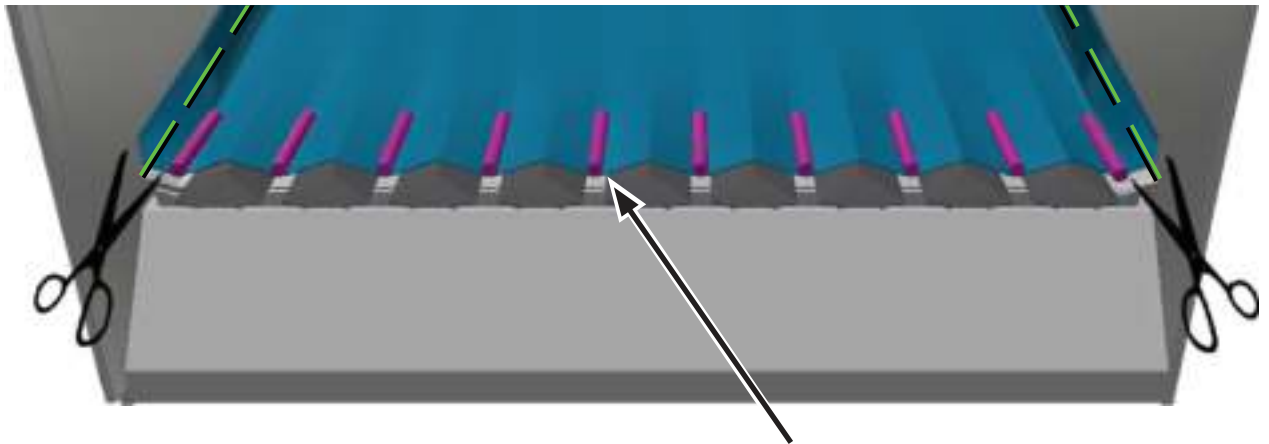

Example of weights

3.7 Optional - Tarp Catch Hooks

Installing catch hooks on the end of the trailer will catch and hold the tarp and make sure that it doesn't get buried in the load.

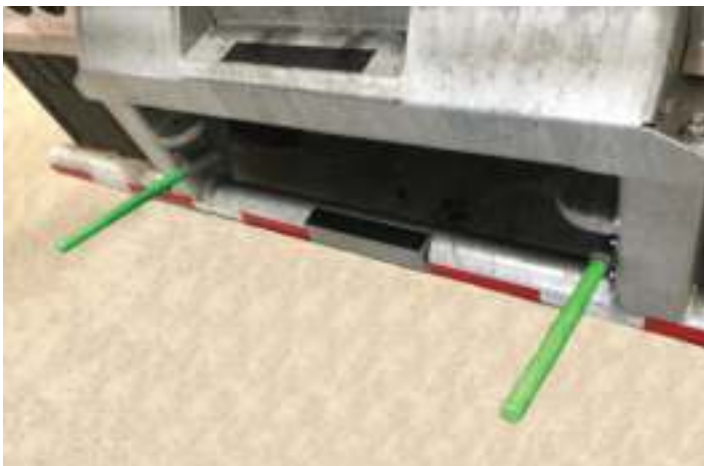

3.8 Winch Brake Adjustment - Wedge Style

The winch brake retains the tarp in the retracted position at the top of the front wall during loading, transport, and the beginning of the unloading cycle. The brake can be adjusted from the top or the bottom using either pair of jam nuts, whichever side is easiest to access.

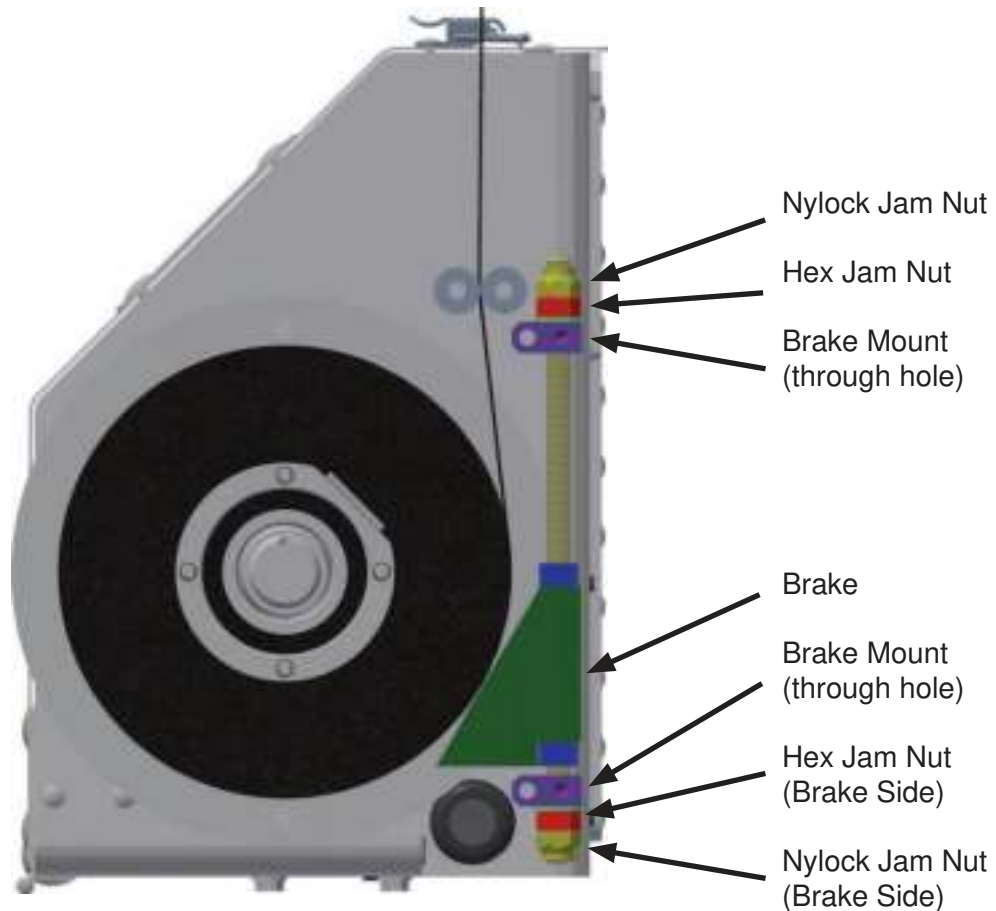

1. Retract the tarp completely to the top of the front wall.
2. Turn whichever pair of jam nuts is easiest to reach, to turn the threaded rod to adjust the brake. A deep socket on a ratchet works well to do this. While turning the jam nut pair, to turn the threaded rod, it can help to put a finger on the wedge brake piece to make sure that the brake is traveling in the direction that you want it to if you can't easily see it. Turn the threaded rod to tighten the brake against the strap until it takes about 10 lbs [5 kg] of force to move the tarp (it should be possible, but take some effort to pull the tarp down by hand).

4.0 Operation

4.1 System Check - Initial Start-up

- ✓ Read through this manual. If there is any confusion, contact a KEITH representative and resolve any concerns before operation of this system
- ✓ Inspect all fasteners and fittings for proper torque.
- ✓ Inspect that all wiring is secured to the trailer frame; avoiding sharp edges, kinks, and stretching.
- ✓ Inspect that connectors and electrical connections are installed per instructions.

Test the system (two people are necessary for this section).

1. Important: Prior to entering the trailer, verify all systems are disabled.
2. Pull the tarp near to the end of the floor slats with the slats in the retracted position (toward the front) and exit, leaving the tarp extended.

IMPORTANT: The strap length must prevent the top pipe from extending past the end of the trailer. Winch retraction depends on a freely moving tarp and retraction may stop prematurely if an obstacle is detected. If this occurs, clear the obstacle and restart.

3. Twist the <ESTOP> button to release the safety and arm the system.
4. Engage the <MANUAL> mode switch.
 - a. Press and hold the <RETRACT> switch.
 - b. Have an assistant verify the tarp retracts only while the switch is depressed.
 - c. Press the <HOLD> switch.
 - d. Have an assistant pull on the tarp and verify it is being held by the winch.
 - e. Press the <ESTOP> button and verify that both these functions are now disabled.
5. Engage the <AUTO> switch.
 - a. Press the <RETRACT> switch momentarily and release.
 - b. With the <ESTOP> button still pressed in from above, nothing should happen.
 - c. Twist the <ESTOP> button and release to enable the system.
 - d. Press the <RETRACT> switch momentarily and release.
 - e. Have an assistant verify the tarp fully retracts and stops at the top.
 - f. If the wedge brake is adjusted properly, the tarp should be held in place at the top. If too tight, the winch may consider this an obstacle and stop retraction before the tarp reaches the top.
6. If any of the above tests fail, review the installation and troubleshooting sections and make corrections as necessary.



4.2 Normal Operation

1. Verify that the tarp is fully retracted and that there is 12"-14" [305-356 mm] of tarp covering the floor slats prior to loading the trailer. It is recommended that a viewing window/port be installed in the top of the front trailer wall so the operator can verify that the tarp is fully retracted from the winch operating position prior to loading.
2. Enable the winch by twisting and releasing the <ESTOP> button.

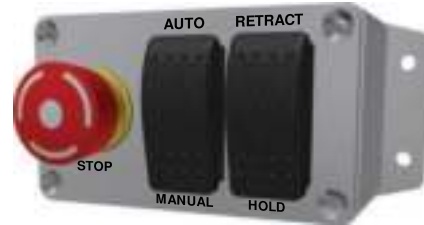

3. Begin the unloading process. Optional: Pressing the <HOLD> button for a few seconds prior to allowing the tarp to travel freely helps to prevent material from sluffing off behind the tarp during unloading. <HOLD> works in both <AUTO> and <MANUAL> modes.
4. **DO NOT let material build up on tarp.** It is recommended that the trailer be moved forward periodically during unloading and especially near the end of the unloading cycle, move it 6'-10' [1830-3050 mm] to reduce the amount of material unloaded on top of the tarp.

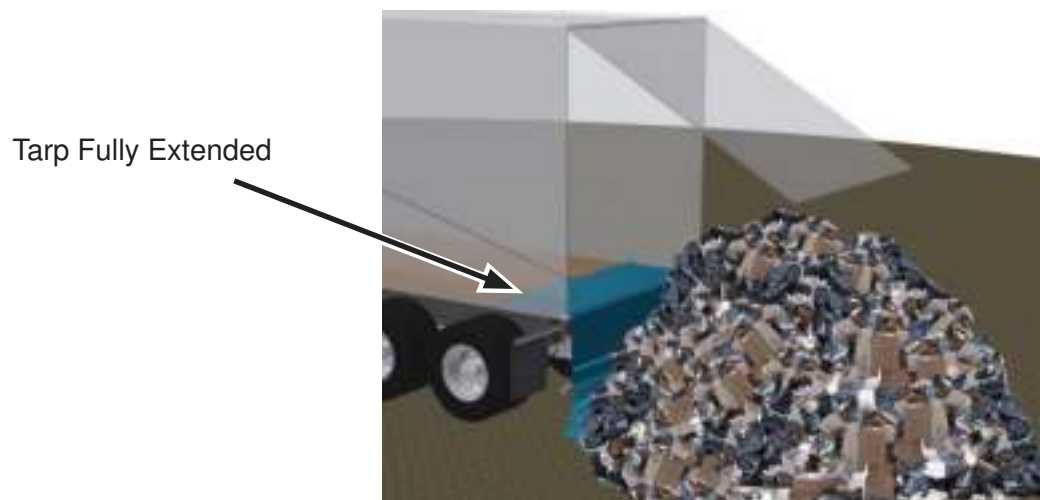

5. After unloading the trailer make sure to stop the floor with all of the slats to the front of the trailer. Dislodge the tarp by hand from underneath any material that may have been unloaded on top of the tarp. **DO NOT attempt to pull the tarp from under a load by using the winch or moving the trailer** – this may damage the winch, tarp, strap or trailer. Installing catch hooks (optional) on the end of the trailer will catch and hold the tarp and make sure that it doesn't get buried in the load.
6. Retract the tarp using either <MANUAL> <RETRACT>, OR <AUTO><RETRACT> modes.
7. The tarp takes ~30 seconds to retract in <AUTO> mode, and when fully retracted will be drawn up to the strap roller. Full retraction can be verified through the viewing window/port (if installed). While it is possible to determine that the tarp has fully retracted without viewing by listening to the system, it may be difficult due to the quietness of the winch system. At this point, verify that the tarp is fully retracted prior to loading the trailer.
8. Press <ESTOP> to disable the winch system.

Note: The winch system utilizes a local battery and will allow operation with or without the tractor running, or being present.

5.0 Troubleshooting

5.1 Check List

Before contacting KEITH for technical assistance, please verify the following:

- ✓ Is your system installed as described in the installation instructions? Is everything wired per the wiring diagram?
- ✓ E-Stop: Is the emergency stop button pulled out?
- ✓ Is there sufficient voltage? Measuring between the 12 VDC and ground wire should show 13 VDC while the tractor is running.
- ✓ Are all connectors mated correctly?
- ✓ Is there any visible damage to the winch, control box, or cables?
- ✓ Are there any obstacles that might prevent retraction?
- ✓ Is the brake not adjusted properly and prematurely stopping the tarp?

5.2 Problem / Solution - Troubleshooting

<u>Problem:</u>	Tarp will not stay at the top of the trailer after retracting.
<i>Possible Cause:</i>	Brake is not properly adjusted.
<i>Solution:</i>	See adjustment section for instructions on how to properly adjust the brake.
<u>Problem:</u>	Tarp stops before fully retracting.
<i>Possible Cause #1:</i>	Tarp is getting caught.
<i>Solution:</i>	Remove any obstacles for the tarp.
<i>Possible Cause #2:</i>	Logic module is failing.
<i>Solution:</i>	Replace the logic module (located inside the winch enclosure).
<i>Possible Cause #3:</i>	Brake set too tight.
<i>Solution:</i>	Adjust brake.
<u>Problem:</u>	Winch system is non-operational.
<i>Possible Cause #1:</i>	<ESTOP> button is not pulled out.
<i>Solution:</i>	Pull out the <ESTOP> button and check that a black indicator ring is visible.
<i>Possible Cause #2:</i>	Connectors are not fully engaged.
<i>Solution:</i>	Check all connectors and make sure that they all have a solid connection.
<i>Possible Cause #3:</i>	Insufficient power.
<i>Solution:</i>	Confirm that the voltage between the +12 VDC and GND wires is +13 VDC.

5.3 Electrical

CHARGER OPERATION		
STAT_1	STAT_2	OPERATION
OFF	OFF	No charge or charger fault
ON	OFF	Absorption phase
OFF	ON	Float phase
ON	ON	Bulk or Pre-conditioning phase

VOLTAGE (Local battery - VDC)	CONDITION
<3	Shorted battery – charger remains shut down
~3 - 10.1	Pre-conditioning at reduced current
10.1 - 14.4	Bulk charging- Current @ maximum
14.4	Absorption – Voltage maintained at maximum, current reducing
13.3	Float – Battery maintained here indefinitely with trickle charge.
12.6	Bulk restarts

6.0 Parts Catalog

Winch Part Comparison Lists

*Serial number must be provided to determine actual part numbers.

10786501
Battery Powered
- V2

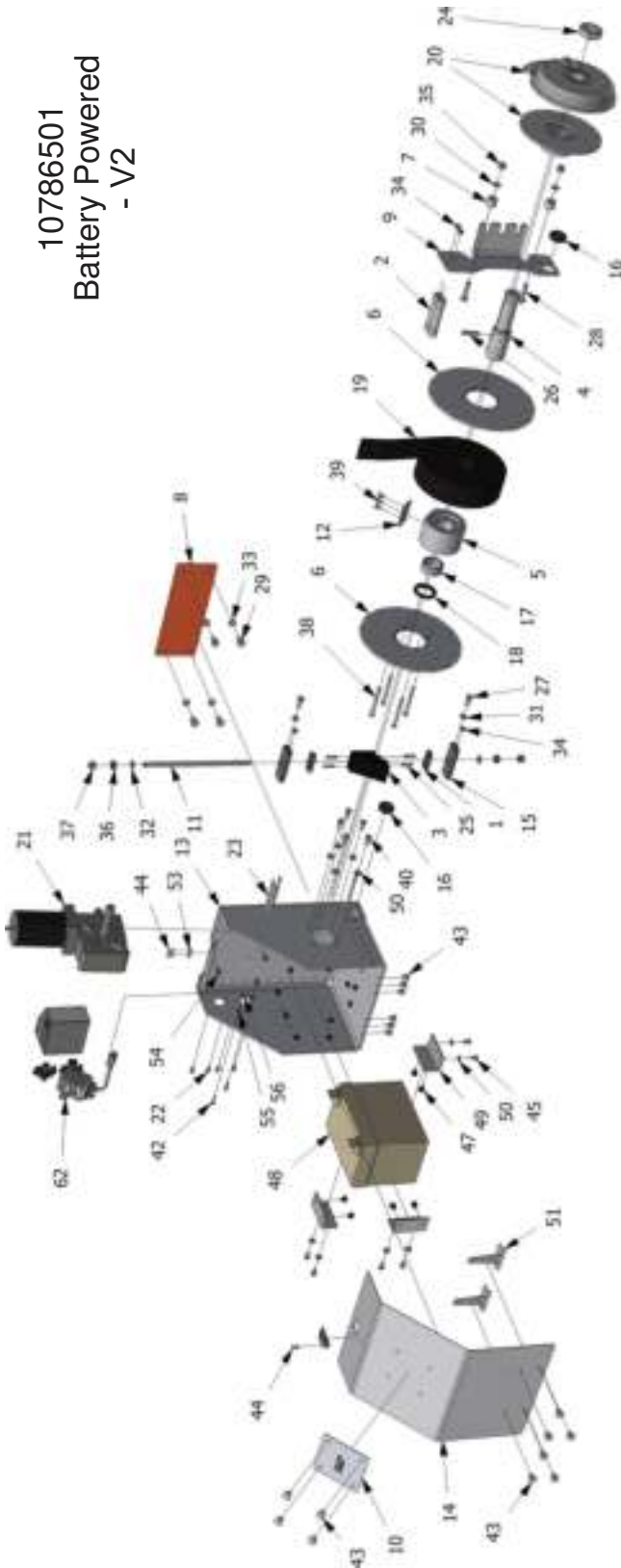

10451101
Direct Connect

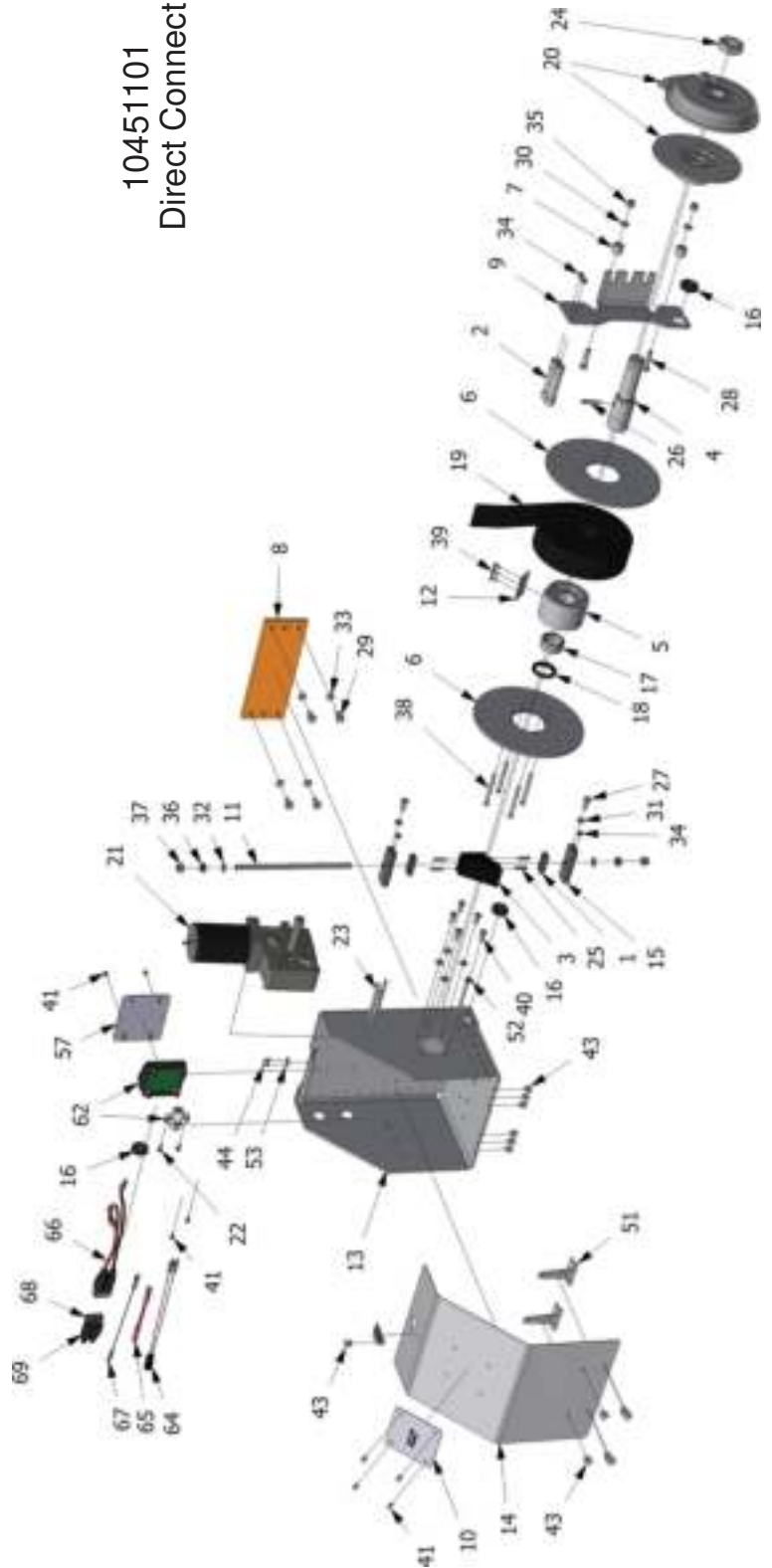

*Serial number must be provided to determine actual part numbers.

09434002
Battery Powered
- V1

Obsolete

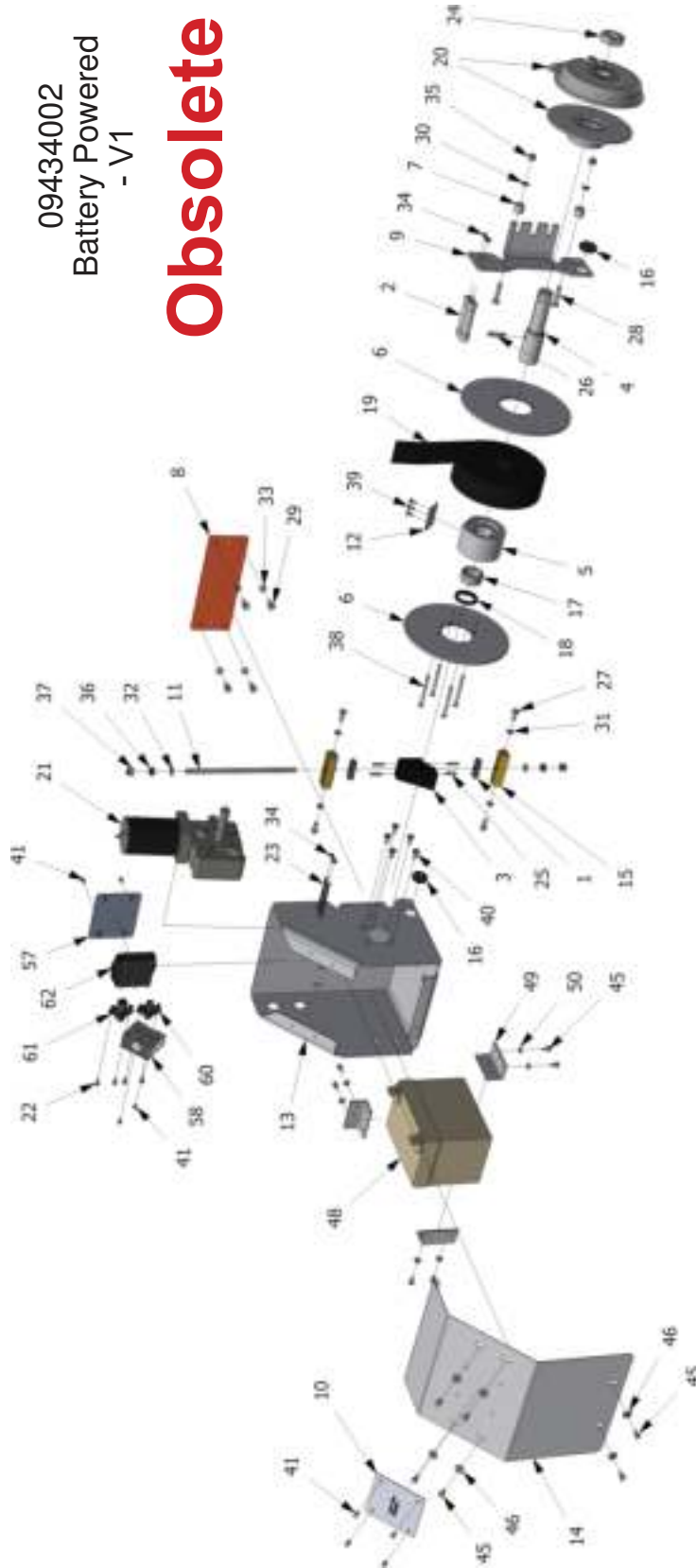

ID #	Qty	Qty	Qty	Part #	DESCRIPTION
-	-			10786501	CSE WINCH ASSY CSE-U v2.0 10-30 VOLT (Includes items 1-62)
-		-		10451101	CSE WINCH ASSY CSE v2.0 Direct Connect (Includes items 1-67)
-			-	09434002	CSE WINCH ASSY CSE v1.0 10-30V (Includes items 1-63) (OBSOLETE)
1	2	2	2	08418801	BRAKE HOLDING NUT FOR WINCH #08387701
2	2	2	2	08419101	STRAP GUIDE FOR WINCH #08387701
3	1	1	1	09095201	BRAKE, 30 DEGREE ANGLE, FOR CS WINCH
4	1	1	1	09301201	WINCH MOTOR HUB ADAPTER WITH EXTENDED SHAFT FOR BEARING SUPPORT
5	1	1	1	09309301	WINCH DRUM HUB, ELECTRIC CLEENSWEEP
6	2	2	2	09309401	WINCH SIDE PLATE, ELECTRIC CLEENSWEEP
7	2	2	2	09390901	STANDOFF, ALUMINUM, 19/32 X 3/4, .315 I.D.
8	1	1	1	09433401	BASE PLATE, AL, 11 X 4 X .5
9	1	1	1	09433601	SIDE SUPPORT, CLUTCH SIDE, CS-E
10	1	1	1	09563801	LASER PLATE, 4" X 4", CSE
11	1	1	1	09563901	ALL THREAD, 10MM X 246MM, CSE
12	1	1	1	10114801	STRAP CLAMP, CSE
13	-	-	1	09473901	CASE ASSEMBLY, CSE - WELDED
	1	1	-	10899401	CASE ASSEMBLY, CSE - RIVETED
14	-	-	1	09433901	SHROUD, CS-E - BOLTED
	1	1	-	10899501	SHROUD, CS-E - HINGED & LATCHED
15	-	-	2	09508101	BRAKE HOLDING MOUNT - V1
	2	2		11033601	BRAKE HOLDING MOUNT - V2
16	2	3	2	83218402	GROMMET 1-1/6"x3/16"x1-3/8"
17	1	1	1	84403704	WEAR RING 1.75 X .750 X .125
18	1	1	1	84426550	WIPER ROD 1.5" ID 56H-1500
19	1	1	1	85811075	STRAP POLYESTER 2" X 75' (+/- 10")
20	-	-	1	85819480	XTREME CLUTCH - X0266
	1	1	-	11423401	CLUTCH 85819480 WITH MODIFICATIONS CSE
21	1	1	1	85820095	MOTOR ELECTRIC, 12V, 600 WATT, 60:1
22	4	2	4	86404510	BOLT HWH ROLOCK #10-32X1/2
23	-	-	2	86407048	BOLT M6X100MM ZN - FH SLOTTED
	4	4	-	86438040	BOLT M6X100MM ZN - CARRIAGE
24	1	1	1	86628112	1-1/8-12 UNF JAM NUT
25	4	4	4	86651425	PIN ROLL 1/4"X1" ZINC
26	1	1	1	86654530	PIN COILED SPRING 8MMX35MM
27	2	2	4	87005770	BOLT HEX GR8.8 8MMX20MM
28	2	-	2	87701697	BOLT FLOOR 8MMX40MM FHCS
	-	2	-	87005950	BOLT HEX 8.8 8-1.25MM X 35MM ZN

ID #	Qty	Qty	Qty	Part #	DESCRIPTION
29	4	4	4	87008470	BOLT HEX 10.9 10MMX20MM
30	2	2	2	87075700	WASHER FLAT 8MM
31	2	2	4	87075750	WASHER LOCK 8MM
32	2	2	2	87076000	WASHER FLAT 10MM
33	4	4	4	87076500	WASHER LOCK 10MM
34	4	4	4	87100500	NUT HEX NYLOCK 6mm
35	2	2	2	87101000	NUT HEX NYLOCK 8mm
36	2	2	2	87101500	NUT HEX 10MM
37	2	2	2	87102000	NUT HEX NYLOCK 10mm
38	4	4	4	87401005	BOLT FLOOR 1/4 X 3
39	3	3	3	87701500	BOLT FLOOR 6MMX12MM
40	-	-	5	87701599	BOLT FLOOR 8MM X 20MM ZINC
	5	5	-	87009007	BOLT BUTTON HEAD M8-1.25 X 20MM ZINC - BUTTON SOCKET CAP SCREW 10.9
41	-	8	8	86528000	POP RIVET - 0.1875 x 0.251 (0.251 - .375) Steel, Mild
42	2	-	-	86426742	BOLT BUTTON HEAD SS #10-32 X 7/8" Fastenal# 73760
43	16	13	-	86528100	POP RIVET - 0.1875 x 0.188 (0.188 - 0.25) Steel, Mild
44	3	2	-	86526410	POP RIVET - 0.125 x 0.2985 (0.251 - 0.312) Steel, Mild
45	6	-	12	87002460	BOLT HEX GR8.8 6MMX12MM
46	-	-	6	87075410	FENDER WASHER - 6MM
47	16	-	-	85712062	PUSH-IN BUMPER FOR 1/4" ID, 1/4" STEM HEIGHT, 1/2" OD, 7/32" HIGH, SBR
48	1	-	1	85711450	BATTERY, AGM, GROUP U1
49	3	-	3	09433501	BATTERY CLAMP, AL ANGLE, FOR CS-E
50	6	-	6	86550552	WASHER FLAT #12
51	2	2	-	85712061	STRAP HINGE 1-1/16" X 2-7/8" DOOR LEAF, ZINC
52	5	5	-	87076503	WASHER LOCK INTERNAL TOOTH 5/16" ZINC
53	1	1	-	85712037	DRAW LATCH, SCREW ON, 2-5/16" LONG X 15/16" WIDE - 1590A130
54	2	-	-	86404518	SCREW THREAD CUTTING HWH TYPE F #12-24X5/8
55	2	-	-	86550553	WASHER FLAT SS #10 F/W S/S.218X.437
56	2	-	-	86625814	NUT NYLOCK SS #10 -32
57	-	1	1	09562301	SERIAL PLATE, 5" X 4-1/8", CSE LOGIC MODULE
58	-	-	1	85805002	BUCK BOOST CONVERTER, DC, 8-40V IN, 13.8V OUT
59	1	-	1	09562101	EXTERNAL POWER CABLE, 1/2', CSE (NOT SHOWN)
60	-	-	1	09508005	AMPHENOL AT04-2P-PM11
61	-	-	1	09508006	AMPHENOL AT04-6P-PM11

ID #	Qty	Qty	Qty	Part #	DESCRIPTION
	-	-	1	85721339	CSE, ASSEMBLY, WINCH LOGIC CONTROL MODULE, LOAD SENSE AND CURRENT LIMITING
62	1	-	-	10794301	CSE_2.0 CONTROL MODULE PRODUCTION ASSEMBLY 12/24VDC
	-	1	-	10812601	CSE_1.0 BATTERYLESS WINCH LOGIC CONTROL MODULE ASSY (USES PBA PN: 10812801 & Wiring Kit 10792001)
63	-	-	1	85721335	ELECTRICAL WIRING KIT, CSE WINCH INTERNAL (NOT SHOWN)
64	-	1	-	11509801	WIRE ASSEMBLY, CLUTCH POWER
65	-	1	-	11505601	WIRE ASSEMBLY 8GA WITH RING TERMINALS
-	-	-	-	10325001	CSE BATTERY DELETE KIT (Includes items #64-68 & (1) #16)
66	-	1	-	10329601	CSE CABLE ASSY 8AWG PAIR (RED 13.5", BLK 16", W/ GRAY SB50 HOUSING & CONTACTS (includes connectors & contacts)
67	-	1	-	10341001	CSE BATTERY DELETE KIT GROUND WIRE ASSY
68	-	1	-	85603939	CONNECTOR HOUSING SB50 2-BLADE KIT GRAY SB50-08-GRY
69	-	2	-	85761853	SAFETY BOOT CORROSION PROOF BLK FOR SB50 POWERWERX # BOOT-SB50
70	-	2	-	85603948	CONTACT CONNECTOR SB50 8AWG CRIMP SILVER # 647878-1
71	-	1	-	10372301	CSE DELETE KIT 15A FUSE ASSY W/ CONNECTORS

Conversion Kit - Battery Powered to Direct Connection System

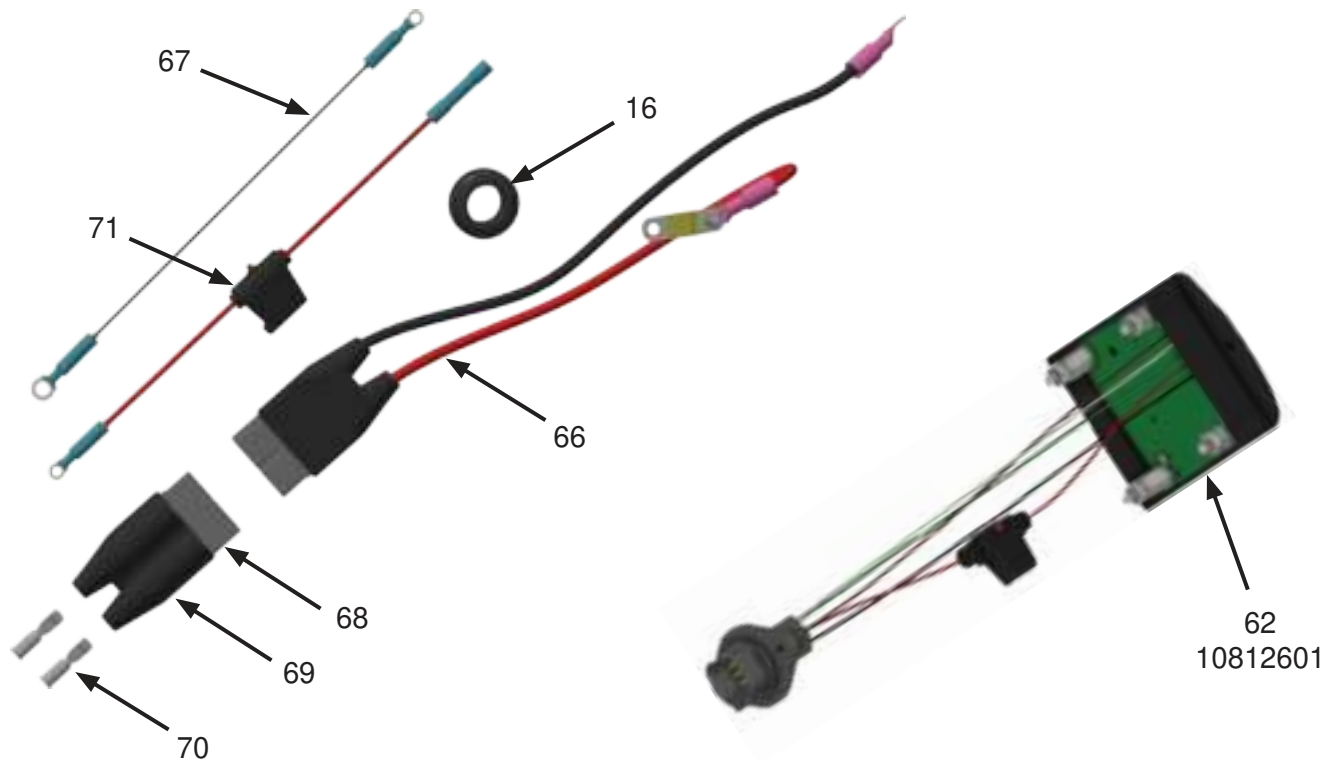

Strap Roller Assembly



ID #	Qty	Qty	Part #	Description
-	-	-	06250301	STRAP ROLLER ASSEMBLY, AL - METRIC (Includes items 1-5)
-	-	-	06250302	STRAP ROLLER ASSEMBLY, SS - METRIC (Includes items 1-5)
1	1	-	06250401	STRAP ROLLER BRACKET UNVL AL
	-	1	06250402	STRAP ROLLER BRACKET UNVL SS - UNIVERSAL MOUNT
2	1	1	05795501	STRAP ROLLER
3	1	1	05813401	STRAP ROLLER BUSHING
4	1	1	87013400	BOLT HEX 10.9 12MMX90MM
5	1	1	87102500	NUT HEX NYLOCK 12MM-1.75 ZINC

Wiring Components

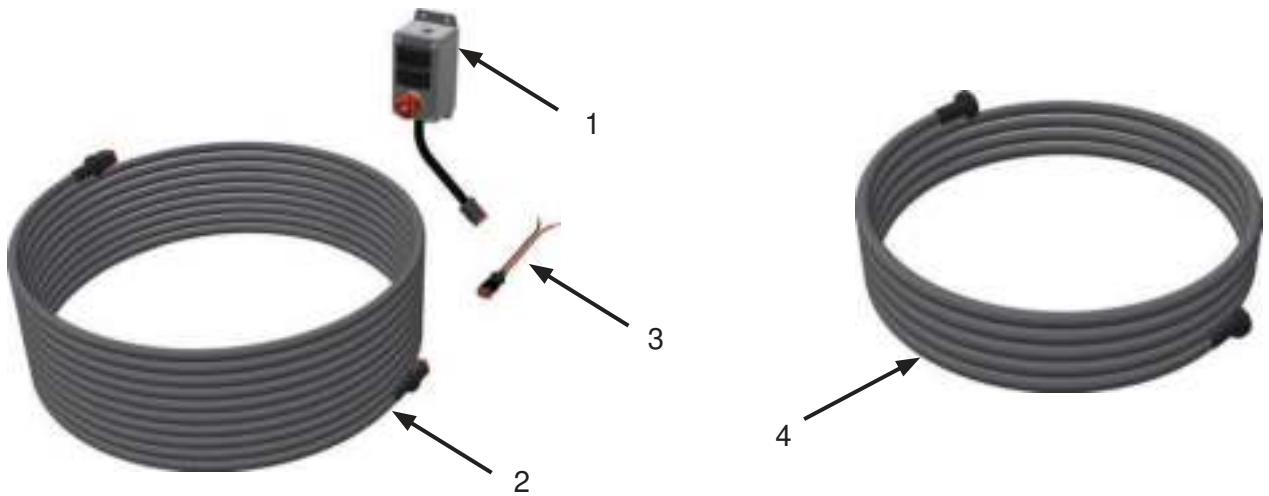

ID #	Qty	Qty	Part #	Description
-	-	-	09663201	EXTERNAL WIRING ASSY CSE 2.0 10-30V (Includes items 1-3)
-	-	-	09663202	DIRECT CONNECT EXTERNAL WIRING ASSY CSE (Includes items 1-2)
1	1	1	09412301	Winch Switch Control Box
2	1	1	09509001	45' Control Cable, Deutsch Connectors
3	1	-	09562101	Power Cable Whip, 6", 2 Pin Deutsch Connector, Bullet Connectors
4	-	-	09509101	15' Cable Extension, Deutsch Connectors

Tarp & Misc Components

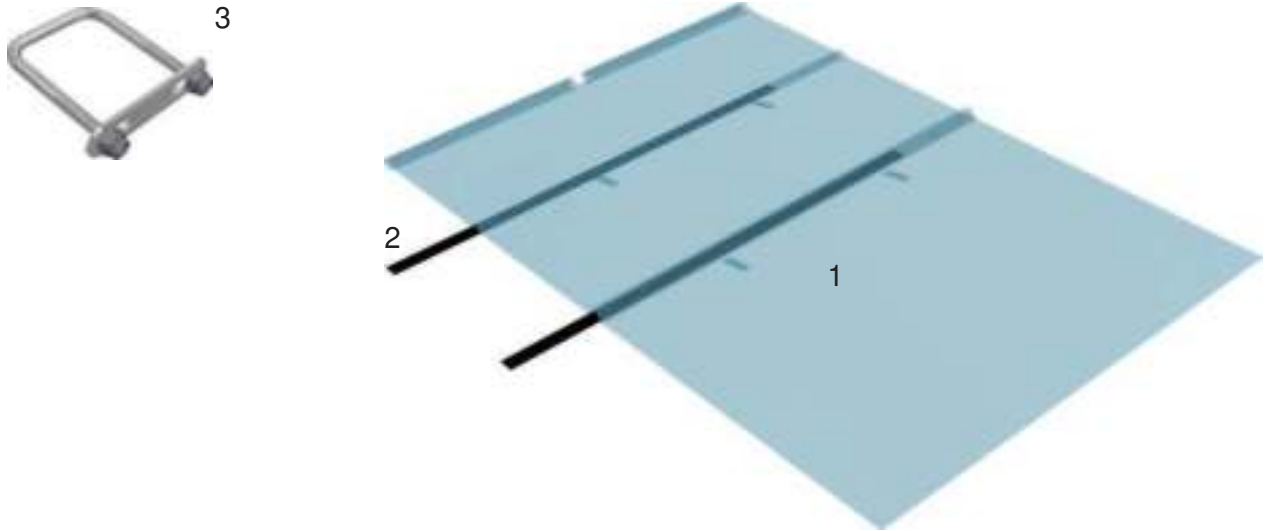

ID #	Qty	Part #	Description
1	1	09169001	TARP, 18 OZ. VINYL, TRIM-TO-FIT (STANDARD)
2	2	03540110	UHMW STRIP BLACK 1/4" X 2-7/8" X 102", NO HOLES
3	1	86671112	BOLT U SQ ASSY M8X2"IX3"ILX1-1/2 THREAD

Winch Reference Drawing

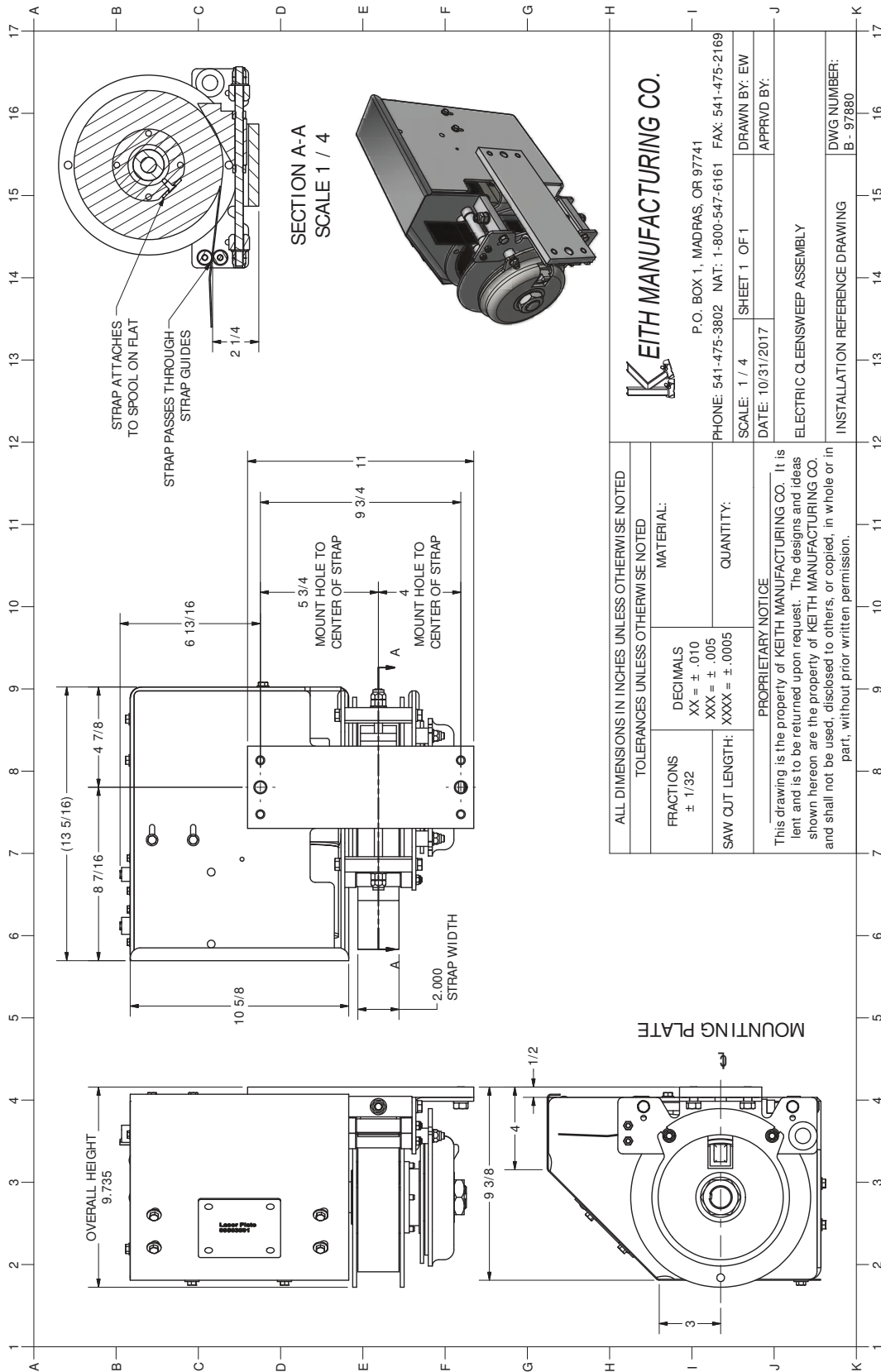

CSE v2.0 Battery Powered System -10794201

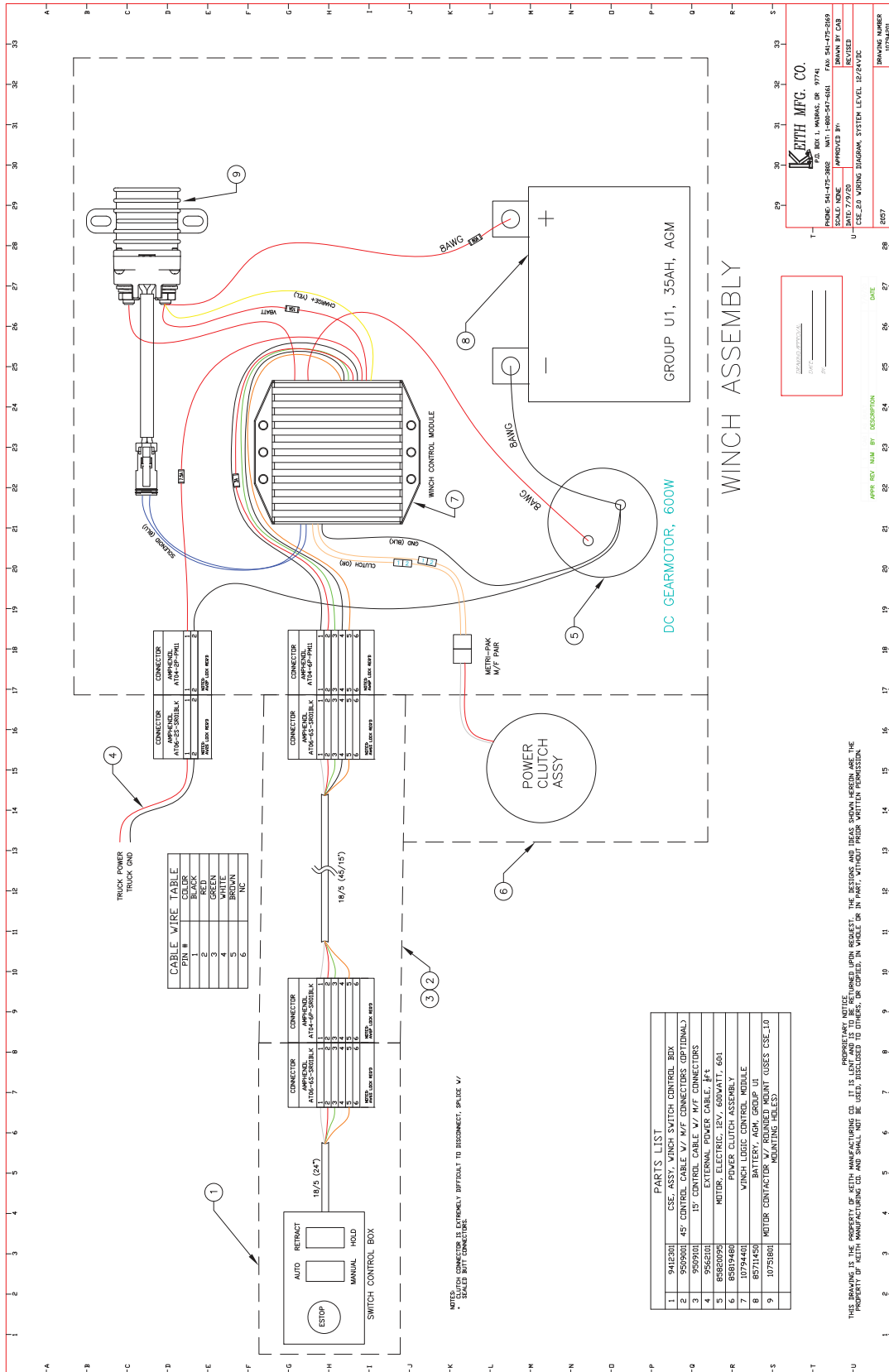

THIS DRAWING IS THE PROPERTY OF KEITH MANUFACTURING CO. IT IS LOANED AND IS TO BE RETURNED UPON REQUEST. THE DESIGN AND IDEAS SHOWN HEREIN ARE THE PROPERTY OF KEITH MANUFACTURING CO. AND SHALL NOT BE USED, DISCLOSED TO OTHERS, OR COPIED, IN WHOLE OR IN PART, WITHOUT PRIOR WRITTEN PERMISSION.

7.0 Technical Support

Please have the following information readily available before contacting KEITH Manufacturing Co. for support:

- Model Number (Located on the Serial Plate of the unit or engraved)
- Serial Number (Located on the Serial Plate on the unit or engraved)
- Vehicle make and unit installer

KEITH Technical Support Contact Information:

Website: www.KeithWalkingFloor.com

Email: TechDept@KeithWalkingFloor.com

Toll-Free: 800-547-6161

Phone: +1-541-475-3802

8.0 Contact Information - KEITH Manufacturing Co.

World Headquarters - USA

401 NW Adler St.

P.O. Box 1

Madras, OR 97741

Toll-Free: 800-547-6161

Phone: +1-541-475-3802

Email: Sales@KeithWalkingFloor.com

Europe Headquarters

Barneveld, The Netherlands

Phone: +31-342-422007

Email: EuroSales@KeithWalkingFloor.com

Canada

Brantford, ON

Phone: +1-519-756-9178

Email: CanadaSales@KeithWalkingFloor.com

México

Guadalajara, Jal.

Phone: +52-333-616-5079

Email: KMC_Mexico@KeithWalkingFloor.com

Australia

Waverley Gardens, VIC

Phone: +61-3-9562-2190

Email: AUSales@KeithWalkingFloor.com